

FOR CAR USE ONLY/NUR FÜR AUTOMOBIL GEBRAUCH/POUR APPLICATION AUTOMOBILE UNIQUEMENT/PARA USO EN AUTOMÓVILES/SOLO PER L'UTILIZZO IN AUTOMOBILE/ENDAST FÖR BILBRUK/ALLEEN VOOR GEBRUIK IN DE AUTO/ ТОЛЬКО ДЛЯ ИСПОЛЬЗОВАНИЯ В АВТОМОБИЛЯХ/DO UŻYCIA TYLKO W SAMOCHODZIE/ΓΙΑ ΧΡΗΣΗ ΜΟΝΟ ΣΕ ΑΥΤΟΚΙΝΗΤΟ

ALPINE®

ADVANCED BLUETOOTH CD RECEIVER CDE-133BT

CD RECEIVER WITH USB AND iPod CONTROLLER CDE-131R



(CDE-133BT only)

- OWNER'S MANUAL
Please read before using this equipment.
- BEDIENUNGSANLEITUNG
Lesen Sie diese Bedienungsanleitung bitte vor Gebrauch des Gerätes.
- MODE D'EMPLOI
Veuillez lire avant d'utiliser cet appareil.
- MANUAL DE OPERACIÓN
Léalo antes de utilizar este equipo.
- ISTRUZIONI PER L'USO
Si prega di leggere prima di utilizzare il attrezzatura.
- ANVÄNDARHANDLEDNING
Innan du använder utrustningen bör du läsa igenom denna användarhandledning.
- GEBRUIKERSHANDLEIDING
Lees deze aanwijzingen aandachtig alvorens dit toestel te gebruiken.
- РУКОВОДСТВО ПО ЭКСПЛУАТАЦИИ
Прочтите настоящее руководство перед началом использования оборудования.
- INSTRUKCJA OBSŁUGI
Prosimy zapoznać się z tą instrukcją przed przystąpieniem do użytkowania urządzenia.
- ΕΓΧΕΙΡΙΔΙΟ ΧΡΗΣΤΗ
Παρακαλούμε διαβάστε το πριν χρησιμοποιήσετε τη συσκευή.

ALPINE ELECTRONICS MARKETING, INC.
1-1-8 Nishi Gotanda,
Shinagawa-ku,
Tokyo 141-0031, Japan
Phone 03-5496-8231

ALPINE ELECTRONICS OF AMERICA, INC.
19145 Gramercy Place, Torrance,
California 90501, U.S.A.
Phone 1-800-ALPINE-1 (1-800-257-4631)

ALPINE ELECTRONICS OF CANADA, INC.
777 Supertest Road, Toronto,
Ontario M3J 2M9, Canada
Phone 1-800-ALPINE-1 (1-800-257-4631)

ALPINE ELECTRONICS OF AUSTRALIA PTY. LTD.
161-165 Princes Highway, Hallam
Victoria 3803, Australia
Phone 03-8787-1200

ALPINE ELECTRONICS GmbH
Wilhelm-Wagenfeld-Str. 1-3, 80807 München, Germany
Phone 089-32 42 640

ALPINE ELECTRONICS OF U.K. LTD.
Alpine House
Fletchamstead Highway, Coventry CV4 9TW, U.K.
Phone 0870-33 33 763

ALPINE ELECTRONICS FRANCE S.A.R.L.
(RCS PONTOISE B 338 101 280)
98, Rue de la Belle Etoile, Z.I. Paris Nord II,
B.P. 50016, 95945 Roissy Charles de Gaulle
Cedex, France
Phone 01-48638989

ALPINE ITALIA S.p.A.
Viale C. Colombo 8, 20090 Trezzano
Sul Naviglio (MI), Italy
Phone 02-484781

ALPINE ELECTRONICS DE ESPAÑA, S.A.
Portal de Gamarra 36, Pabellón, 32
01013 Vitoria (Alava)-APDO 133, Spain
Phone 945-283588

ALPINE ELECTRONICS (BENELUX) GmbH
Leuvensesteenweg 510-B6,
1930 Zaventem, Belgium
Phone 02-725-13 15

EN

DE

FR

ES

IT

SE

NL

RU

PL

GR

Operating Instructions

WARNING

WARNING	6
CAUTION	6
PRECAUTIONS	6

Getting Started

Accessory List	9
Turning Power On and Off	9
Source Selection	9
Detaching and Attaching the Front Panel	9
Detaching	9
Attaching	9
Initial System Start-Up	9
Adjusting Volume	10
Setting Time	10

Radio

Listening to Radio	11
Presetting Stations Manually	11
Presetting Stations Automatically	11
Tuning to Preset Stations	11
Frequency Search Function	11

RDS

Turning AF (Alternative Frequencies) ON/OFF	12
Receiving RDS Regional (Local) Stations	12
PI SEEK Setting	12
Setting the Time to automatically Adjust	12
Receiving Traffic Information	13
Displaying Radio Text	13

CD/MP3

Playback	13
Repeat Play	14
M.I.X. (Random Play)	14
Searching for CD Text	14
Folder/File Name Search (concerning MP3) ...	14
Folder Name Search mode	14
File Name Search mode	14
About MP3	15
Terminology	15

Sound Setting

Adjusting Subwoofer Level/Bass Level/Middle Level/Treble Level/Balance (Between Left and Right)/Fader (Between Front and Rear)/ Loudness/Defeat	16
Audio Setup	16
Equalizer Presets (F-EQ)	16
Turning Loudness On/Off	17
Adjusting the Parametric Equalizer Curve (3BAND EQ)	17
Setting the Bass Control	17
Setting the Mid Control	17
Setting the Treble Control	17
Setting the Source Volume Level	18
Adjusting the High Pass Filter	18
Turning Subwoofer ON/OFF	18
Adjusting the Low Pass Filter	18
Setting the Subwoofer Phase	18
Setting the Subwoofer System	18
External Device	18
Connecting to an External Amplifier (Power IC)	18

Other Functions

Displaying the Text	19
About the indication display	19
About "Text"	19
Using the Front AUX Input Terminal	19
Setting your favourite source to the FAV button (FAV SETUP) (CDE-131R only)	20
Set your favourite source	20
Recall your favourite source	20
Option Menu Setting	20

SETUP

Setting	21
General Setting	21
Setting your favourite source to the FAV button (FAV SETUP) (CDE-131R only)	21
Setting the Language (CYRILLIC)	21
Setting the AUX SETUP Mode	21
Turning Mute Mode On/Off (INT MUTE) (CDE-131R only)	22
Playing MP3 Data (PLAY MODE)	22
Demonstration	22
Display Setting	22
Changing Lighting Colour	22
Dimmer Control	22
Scroll Setting (SCROLLTYPE)	22
iPod/iPhone Setting	22
iPod/iPhone Search Mode Setting	22

BLUETOOTH Operation (CDE-133BT only)

Setup Before Using	23
About BLUETOOTH.....	23
Before Using BLUETOOTH Function	23
How to connect to a BLUETOOTH compatible device (Pairing)	23
Pairing a BLUETOOTH compatible device with SSP (Secure Simple Pairing).....	23
Pairing a BLUETOOTH compatible device without SSP (Secure Simple Pairing).....	23
BLUETOOTH SETUP	23
Setting the BLUETOOTH Connection (BT IN)	24
Hands-Free Phone setting (HFP).....	24
BLUETOOTH Audio setting (AUDIO)	24
Setting the BLUETOOTH Device	24
Setting the Visible Mode	24
Pairing a BLUETOOTH Device from the unit	24
Setting the BLUETOOTH sound quality.....	25
Adjusting the volume (VOL LV ADJ).....	25
Sound Auto setting (AUTO SET).....	25
Setting the caller information display/ text message indicator ON/OFF	25
Setting text message indicator ON/OFF (MSG ALERT)	25
Setting the caller information display ON/OFF (CALLER ID)	25
Phone Book Auto Update ON/OFF	25
Setting the BLUETOOTH Menu language ...	25
Changing the Phone book List Order.....	26
Setting the Received Calls automatically (Auto Answer).....	26
Displaying the phone service provider name.....	26
Selecting the output speaker	26
Displaying the firmware version.....	26
Updating the firmware	26
Hands-Free Phone Control	26
About the Hands-Free Phone.....	26
Answering a Call	26
Hanging up the Telephone	27
Calling	27
Voice Dial Operation	27
Redialing a Number In Outgoing History.....	27
Dialing a Number In Incoming History.....	27
Dialing a Number In Incoming Missed Call History	27
Dialing a Number In The Phone Book	28
Phone book alphabet search function	28

Call waiting function	28
Preset a number in the Phone Book (Shortcut dial)	28
Dialing the preset number	28
Adjusting the volume when receiving a Call	29
Muting the microphone input quickly (Voice Mute)	29
Call Switching Operation	29
BLUETOOTH Audio Operation.....	29
Recalling the BLUETOOTH Audio Mode	29
Selecting the desired Song	29
Pausing.....	29

USB Memory (optional)

Playing MP3 Files from USB Memory (optional)	30
USB Memory Connection (optional).....	30
Connect USB Memory.....	30
Remove USB Memory	30
About MP3 File of USB Memory	30

iPod/iPhone (optional)

Connecting an iPod/iPhone.....	31
Setting the iPod Control.....	31
Playback	31
Searching for a desired Song	32
Alphabet search function	32
Direct Search Function	32
Select Playlist/Artist/Album/Genre/ Composer	33
Random Play Shuffle (M.I.X.).....	33
Repeat Play	33

Information

In Case of Difficulty	34
Basic.....	34
Radio	34
CD.....	34
MP3.....	34
Audio.....	34
iPod.....	34
Indication for CD Player.....	34
Indication for USB Memory.....	35
Indication for iPod Mode	35
BLUETOOTH mode (CDE-133BT only)	35
Specifications	36

Installation and Connections

WARNING	37
CAUTION	37
PRECAUTIONS	37
Installation.....	38
Removal.....	38
Mounting the Microphone (CDE-133BT only)	38
Connections.....	39

Operating Instructions

WARNING

WARNING

This symbol means important instructions. Failure to heed them can result in serious injury or death.

DO NOT OPERATE ANY FUNCTION THAT TAKES YOUR ATTENTION AWAY FROM SAFELY DRIVING YOUR VEHICLE.

Any function that requires your prolonged attention should only be performed after coming to a complete stop. Always stop the vehicle in a safe location before performing these functions. Failure to do so may result in an accident.

KEEP THE VOLUME AT A LEVEL WHERE YOU CAN STILL HEAR OUTSIDE NOISES WHILE DRIVING.

Excessive volume levels that obscure sounds such as emergency vehicle sirens or road warning signals (train crossings, etc.) can be dangerous and may result in an accident. LISTENING AT LOUD VOLUME LEVELS IN A CAR MAY ALSO CAUSE HEARING DAMAGE.

DO NOT DISASSEMBLE OR ALTER.

Doing so may result in an accident, fire or electric shock.

USE ONLY IN CARS WITH A 12 VOLT NEGATIVE GROUND.

(Check with your dealer if you are not sure.) Failure to do so may result in fire, etc.

KEEP SMALL OBJECTS SUCH AS BATTERIES OUT OF THE REACH OF CHILDREN.

Swallowing them may result in serious injury. If swallowed, consult a physician immediately.

USE THE CORRECT AMPERE RATING WHEN REPLACING FUSES.

Failure to do so may result in fire or electric shock.

DO NOT BLOCK VENTS OR RADIATOR PANELS.

Doing so may cause heat to build up inside and may result in fire.

USE THIS PRODUCT FOR MOBILE 12V APPLICATIONS.

Use for other than its designed application may result in fire, electric shock or other injury.

DO NOT PLACE HANDS, FINGERS OR FOREIGN OBJECTS IN INSERTION SLOTS OR GAPS.

Doing so may result in personal injury or damage to the product.

CAUTION

This symbol means important instructions. Failure to heed them can result in injury or material property damage.

HALT USE IMMEDIATELY IF A PROBLEM APPEARS.

Failure to do so may cause personal injury or damage to the product. Return it to your authorized Alpine dealer or the nearest Alpine Service Centre for repairing.

PRECAUTIONS

Product Cleaning

Use a soft dry cloth for periodic cleaning of the product. For more severe stains, please dampen the cloth with water only. Anything else has the chance of dissolving the paint or damaging the plastic.

Temperature

Be sure the temperature inside the vehicle is between +60°C (+140°F) and -10°C (+14°F) before turning your unit on.

Moisture Condensation

You may notice the CD playback sound wavering due to condensation. If this happens, remove the disc from the player and wait about an hour for the moisture to evaporate.

Damaged Disc

Do not attempt to play cracked, warped, or damaged discs. Playing a bad disc could severely damage the playback mechanism.

Maintenance

If you have problems, do not attempt to repair the unit yourself. Return it to your Alpine dealer or the nearest Alpine Service Station for servicing.

Never Attempt the Following

Do not grip or pull out the disc while it is being pulled back into the player by the automatic reloading mechanism.

Do not attempt to insert a disc into the unit when the unit power is off.

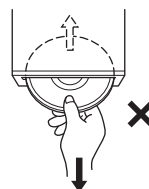

Inserting Discs

Your player accepts only one disc at a time for playback. Do not attempt to load more than one disc.

Make sure the label side is facing up when you insert the disc. "ERROR" will be displayed on your player if you insert a disc incorrectly. If "ERROR" continues to be displayed even though the disc has been inserted correctly, push the RESET button with a pointed object such as a ballpoint pen.

Playing a disc while driving on a very bumpy road may result in skips, but this will not scratch the disc or damage the player.

New Discs

To prevent the CD from jamming, "ERROR" is displayed if discs with irregular surfaces are inserted or if discs are inserted incorrectly. When a new disc is ejected immediately after initial loading, use your finger to feel around the inside of the centre hole and outside edge of the disc. If you feel any small bumps or irregularities, this could inhibit proper loading of the disc. To remove the bumps, rub the inside edge of the hole and outside edge of the disc with a ballpoint pen or other such instrument, then insert the disc again.

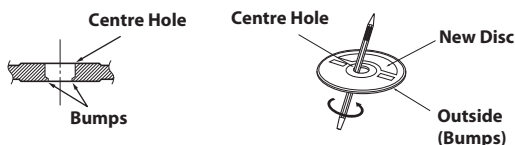

Irregular Shaped Discs

Be sure to use round shape discs only for this unit and never use any special shape discs.

Use of special shape discs may cause damage to the mechanism.



Installation Location

Make sure this unit will not be installed in a location subjected to:

- Direct sun and heat
- High humidity and water
- Excessive dust
- Excessive vibrations

Correct Handling

Do not drop the disc while handling. Hold the disc so you will not leave fingerprints on the surface. Do not affix tape, paper, or gummed labels to the disc. Do not write on the disc.

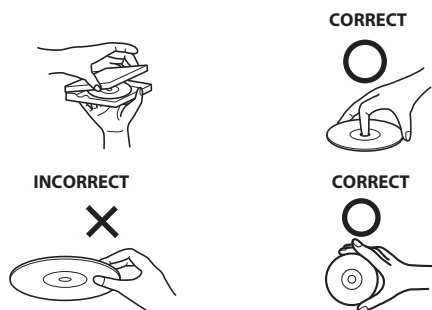

Disc Cleaning

Fingerprints, dust, or soil on the surface of the disc could cause the CD player to skip. For routine cleaning, wipe the playing surface with a clean, soft cloth from the centre of the disc to the outer edge.

If the surface is heavily soiled, dampen a clean, soft cloth in a solution of mild neutral detergent before cleaning the disc.



Disc Accessories

There are various accessories available on the market for protecting the disc surface and improving sound quality. However, most of them will influence the thickness and/or diameter of the disc. Using such accessories can cause the disc to be out of standard specifications and may create operational problems. We recommend not using these accessories on discs played in Alpine CD players.

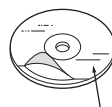

Transparent Sheet

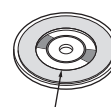

Disc Stabilizer

On handling Compact Discs (CD/CD-R/CD-RW)

- Do not touch the surface.
- Do not expose the disc to direct sunlight.
- Do not affix stickers or labels.
- Clean the disc when it is dusty.
- Make sure that there are no bumps around the disc.
- Do not use commercially available disc accessories.

Do not leave the disc in the car or the unit for a long time. Never expose the disc to direct sunlight. Heat and humidity may damage the CD and you may not be able to play it again.

To customers using CD-R/CD-RW

- If a CD-R/CD-RW cannot be played back, make sure the last recording session was closed (finalised).
- Finalize the CD-R/CD-RW if necessary, and attempt playback again.

About media that can be played

Use only compact discs with the label side showing the CD logo marks below.



If you use unspecified compact discs, correct performance cannot be guaranteed.

You can play CD-Rs (CD-Recordables)/CD-RWs (CD-ReWritables) which have been recorded only on audio devices. You can also play CD-Rs/CD-RWs containing MP3 formatted audio files.

- Some of the following CDs may not play on this unit: Flawed CDs, CDs with fingerprints, CDs exposed to extreme temperatures or sunlight (e.g., left in the car or this unit), CDs recorded under unstable conditions, CDs on which a recording failed or a re-recording was attempted, copy-protected CDs which do not conform to the audio CD industry standard.
- Use discs with MP3 files written in a format compatible with this unit. For details, refer to "About MP3" on page 15.
- ROM data other than audio files contained in a disc will not produce sound when played back.

Protecting the USB Connection Terminal

- Only a USB Flash Memory devices can be connected to the USB connection terminal on this unit. Correct performance using other USB products cannot be guaranteed. A USB hub is not supported.
- Depending on the shape or size of a USB memory, it may not be connected to the USB terminal of this unit—a USB cable (sold separately) is recommended for this connection.
Also, avoid connecting USB memory and Front Aux at the same time.
- If a USB device is inserted in the unit, it projects out and may be a danger while driving.
Use a commercially available USB extension cable, and connect it in a safe way.
- Depending on the connected USB Memory device, the unit may not function or some functions may not be performed.
- The audio file format that can be played back on the unit is MP3.
- Artist/song name, etc., can be displayed, however characters may not be correctly displayed.

On Handling USB Memory

CAUTION

Alpine accepts no responsibility for lost data, etc., even if data, etc., is lost while using this product.

- To prevent malfunction or damage, note the following points.
Read the USB Memory Owner's Manual thoroughly.
Do not touch the terminals by hand or metal.
Do not subject USB Memory to excessive shock.
Do not bend, drop, disassemble, modify or soak in the water.
- Avoid usage or storage in the following locations:
Anywhere in the car exposed to direct sunlight or high temperatures.
Anywhere the possibility of high humidity or corrosive substances is present.
- Fix the USB Memory in a location where driver operation will not be hindered.
- USB Memory may not function correctly at high or low temperature.
- The USB Flash Memory supports only 512 or 2,048 bytes per sector.
- Use only certified USB Memory. Please pay attention that even certified USB Memory, may not function correctly depending on its type or state.
- USB Memory function is not guaranteed. Use USB Memory according to the terms of agreement.
- Depending on the settings of the USB Memory type, memory state or encoding software, the unit may not play back or display properly.
- A file that is copy-protected (copyright protection) cannot be played back.
- USB Memory may take time to start playback. If there is a particular file other than audio in the USB Memory, it may take considerable time before the file is played back or searched.
- The unit can play back "mp3" file extensions.
- Do not add the above extensions to a file other than audio data. This non-audio data will not be recognised. The resulting playback may contain noise that can damage speakers and/or amplifiers.
- It is recommended to back up important data on a personal computer.
- Do not remove the USB device while playback is in progress. Change SOURCE to something other than USB, then remove the USB device to prevent possible damage to its memory.

- *iPhone, iPod, iPod classic, iPod nano, and iPod touch are trademarks of Apple Inc., registered in the U.S. and other countries.*
- *"Made for iPod," and "Made for iPhone," mean that an electronic accessory has been designed to connect specifically to iPod, or iPhone, respectively, and has been certified by the developer to meet Apple performance standards. Apple is not responsible for the operation of this device or its compliance with safety and regulatory standards. Please note that the use of this accessory with iPod, or iPhone may affect wireless performance.*
- *The BLUETOOTH® word mark and logos are registered trademarks owned by the Bluetooth SIG, Inc. and any use of such marks by Alpine Electronics, Inc. is under license.*
- *"MPEG Layer-3 audio coding technology licensed from Fraunhofer IIS and Thomson."*
- *"Supply of this product only conveys a licence for private, non-commercial use and does not convey a license nor imply any right to use this product in any commercial (i.e. revenue-generation) real time broadcasting (terrestrial, satellite, cable and/or any other media), broadcasting/streaming via internet, intranets and/or other networks or in other electronic content distribution systems, such as pay-audio or audio-on-demand applications. An independent license for such use is required. For details, please visit <http://www.mp3licensing.com>"*
- *© 2010 Nokia. All rights reserved. Nokia and Works with Nokia are trademarks or registered trademarks of Nokia Corporation.*

Getting Started

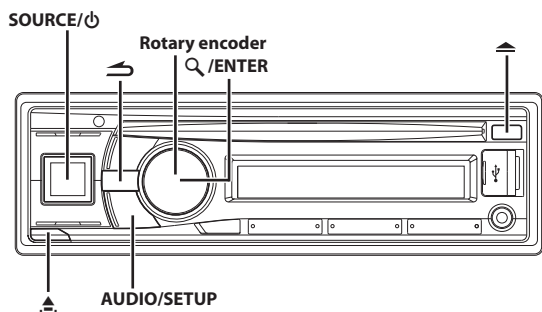

Accessory List

- Head Unit1
- Power Cable1
- Microphone (CDE-133BT only)1
- Mounting Sleeve1
- Carrying Case.....1
- Rubber Cap1
- Hex Bolt.....1
- Screw (M5 × 8)4
- Owner's Manual.....1 set

Turning Power On and Off

Press **SOURCE/⏻** to turn on the unit.

Note

- The unit can be turned on by pressing any other button except **▲** and **△** (Release).

Press and hold **SOURCE/⏻** for at least 2 seconds to turn off the unit.

Note

- The first time power is turned on, the volume will start from level 12.

Source Selection

Press **SOURCE/⏻** to change the source.

TUNER → DISC → USB AUDIO/iPod*1 → BT AUDIO*2 → AUXILIARY*3 → TUNER

*1 Only when the iPod/iPhone is connected.

*2 Only for CDE-133BT.

Only when BT AUDIO is set to ON. Refer to "Setting the BLUETOOTH Connection (BT IN)" on page 24.

*3 Only when AUX SETUP is set to ON. Refer to "Setting the AUX SETUP Mode" on page 21.

Detaching and Attaching the Front Panel

Detaching

- 1 Turn off the unit power.
- 2 Press **▲** (Release) at the lower left side until the front panel pops out.
- 3 Grasp the left side of the front panel and pull it out.

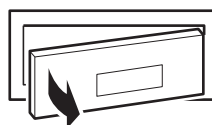

Notes

- The front panel may become hot in normal usage (especially the connector terminals on the back of the front panel). This is not a malfunction.
- To protect the front panel, place it in the supplied carrying case.
- When detaching the front panel, do not apply excessive force as it may result in malfunction.

Attaching

- 1 Insert the right side of the front panel into the main unit. Align the groove on the front panel with the projections on the main unit.
- 2 Push the left side of the front panel until it locks firmly into the main unit.

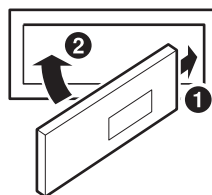

Notes

- Before attaching the front panel, make sure that there is no dirt or dust on the connector terminals and no foreign object between the front panel and the main unit.
- Attach the front panel carefully, holding the sides of the front panel to avoid pushing buttons by mistake.

Initial System Start-Up

Be sure to press the **RESET** button when using the unit for the first time, after changing the car battery, etc.

- 1 Turn off the unit power.
- 2 Remove the detachable front panel.

- 3** Press **RESET** with a ballpoint pen or similar pointed object.

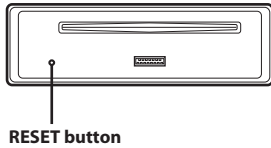

Adjusting Volume

Turn the **Rotary encoder** until the desired sound is obtained.

Setting Time

- 1** Press and hold **AUDIO/SETUP** for at least 2 seconds to activate the **SETUP** selection mode.
- 2** Turn the **Rotary encoder** to select **GENERAL**, and then press **Q/ENTER**.
AUDIO ↔ GENERAL ↔ DISPLAY ↔ TUNER ↔ iPod ↔ BLUETOOTH*
- * CDE-133BT only.
- 3** Turn the **Rotary encoder** to select the **CLOCK ADJ** mode, and then press **Q/ENTER**.
The time indication will blink.
- 4** Turn the **Rotary encoder** to adjust the hours while the time indication is blinking.
- 5** When the hour has been adjusted, press **Q/ENTER**.
- 6** Turn the **Rotary encoder** to adjust the minutes while the time indication is blinking.
- 7** Press and hold **AUDIO/SETUP** for at least 2 seconds to return to normal mode.

Notes

- To synchronize the clock to another clock/watch or radio time announcement, press and hold **Q/ENTER** for at least 2 seconds after setting the "hour". Minutes will reset to "00". If the display shows over "30" minutes when you do this, the time will advance one hour.
- Pressing **↵** will return to the previous mode.
- Pressing and holding **↵** for at least 2 seconds will return to normal mode.
- If no operation is performed for 60 seconds, the unit will return to normal mode automatically.
- Even when **AUTO CLOCK** is set to **ON** (refer to "Setting the Time to automatically Adjust" on page 12), the time can be adjusted manually. At the same time, if there is an adjustment request from RDS, the time will be adjusted automatically by RDS data.

Controllable with Remote Control

This unit can be controlled with an optional Alpine remote control. For details, consult your Alpine dealer. Point the optional remote control transmitter at the remote-control sensor.

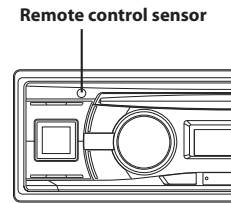

Radio

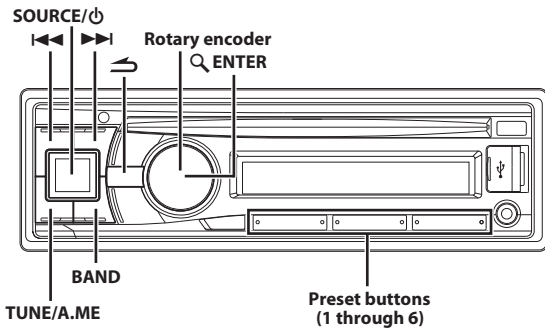

Listening to Radio

- 1 Press **SOURCE/⏻** to select TUNER mode.
- 2 Press **BAND** repeatedly until the desired radio band is displayed.
F1 (FM1) → F2 (FM2) → F3 (FM3) → MW → LW → F1 (FM1)

- 3 Press **TUNE/A.ME** to select the tuning mode.
DX SEEK (Distance mode) → SEEK (Local mode) → off (Manual mode) → DX SEEK

Note

- The initial mode is Distance mode.

Distance mode:

Both strong and weak stations will be automatically tuned in (Automatic Seek Tuning).

Local mode:

Only strong stations will be automatically tuned in (Automatic Seek Tuning).

Manual mode:

The frequency is manually tuned in steps (Manual tuning).

- 4 Press **⏪** or **⏩** to tune in the desired station.
Holding down **⏪** or **⏩** will change the frequency continuously.

Presetting Stations Manually

- 1 Select the radio band and tune in a desired radio station you wish to store in the preset memory.
- 2 Press and hold, for at least 2 seconds, any one of the **preset buttons (1 through 6)** into which you wish to store the station.

The selected station is stored.

The display shows the band, preset number and station frequency memorized.

Notes

- A total of 30 stations can be stored in the preset memory (6 stations for each band; FM1, FM2, FM3, MW and LW).
- If you store a station in a preset memory which already has a station, the current station will be cleared and replaced with the new station.

Presetting Stations Automatically

- 1 Press **BAND** repeatedly until the desired radio band is displayed.
- 2 Press and hold **TUNE/A.ME** for at least 2 seconds.
The frequency on the display continues to change while the automatic memory is in progress. The tuner will automatically seek and store 6 strong stations in the selected band. They will be stored into preset buttons 1 to 6 in order of signal strength. When the automatic memory has been completed, the tuner goes to the station stored in preset location No.1.

Note

- If no stations are stored, the tuner will return to the original station you were listening to before the auto memory procedure began.

Tuning to Preset Stations

- 1 Press **BAND** repeatedly until the desired band is displayed.
- 2 Press any one of the **station preset buttons (1 through 6)** that has your desired radio station in memory.
The display shows the band, preset number and frequency of the station selected.

Frequency Search Function

You can search for a radio station by its frequency.

- 1 Press **Q/ENTER** in Radio mode to activate Frequency search mode.
The "Q" indicator lights up.
- 2 Turn the **Rotary encoder** to select the desired frequency.
- 3 Press **Q/ENTER** to receive the selected frequency.

Note

- Press **↶** in the search mode to cancel. Or, the search mode will be cancelled if no operation is performed for 10 seconds.

RDS

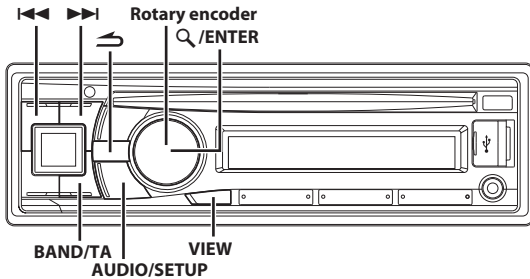



Turning AF (Alternative Frequencies) ON/OFF

The RDS (Radio Data System) is a radio information system using the 57 kHz subcarrier of regular FM broadcast. The RDS allows you to receive a variety of information such as traffic information, station names, and to automatically re-tune to a stronger transmitter that is broadcasting the same programme.

- 1 Press and hold **AUDIO/SETUP** for at least 2 seconds to activate the **SETUP** selection mode.
- 2 Turn the **Rotary encoder** to select the "TUNER" setup mode, and then press **Q/ENTER**.
- 3 Turn the **Rotary encoder** to select the "AF", and then press **Q/ENTER**.
- 4 Turn the **Rotary encoder** to select the AF (Alternative Frequency) **ON** or **OFF** mode.
- 5 Press and hold **AUDIO/SETUP** for at least 2 seconds to return to normal mode.

Notes

- When the AF ON mode is selected, the unit automatically tunes to a strong signal station in the AF list.
- Use the AF OFF mode when automatic re-tuning is not required.
- Press  to return to the previous mode.
- Pressing and holding  for at least 2 seconds will return to normal mode.
- If no operation is performed for 60 seconds, the unit will return to normal mode automatically.



The RDS digital data includes the following:

PI	Programme Identification
PS	Programme Service Name
AF	List of Alternative Frequencies
TP	Traffic Programme
TA	Traffic Announcement

Receiving RDS Regional (Local) Stations

- 1 Press and hold **AUDIO/SETUP** for at least 2 seconds to activate the **SETUP** selection mode.
- 2 Turn the **Rotary encoder** to select the "TUNER" setup mode, and then press **Q/ENTER**.
- 3 Turn the **Rotary encoder** to select the "REGIONAL", and then press **Q/ENTER**.
- 4 Turn the **Rotary encoder** to select **ON** or **OFF**.
In the OFF mode, the unit automatically keeps receiving the related local RDS station.
- 5 Press and hold **AUDIO/SETUP** for at least 2 seconds to return to normal mode.



Notes

- Press  to return to the previous mode.
- Pressing and holding  for at least 2 seconds will return to normal mode.
- If no operation is performed for 60 seconds, the unit will return to normal mode automatically.

PI SEEK Setting

- 1 Press and hold **AUDIO/SETUP** for at least 2 seconds to activate the **SETUP** mode.
- 2 Turn the **Rotary encoder** to select the TUNER mode, and then press **Q/ENTER**.
- 3 Turn the **Rotary encoder** to select PI SEEK, and then press **Q/ENTER**.
- 4 Turn the **Rotary encoder** to select **ON** or **OFF**.
- 5 Press and hold **AUDIO/SETUP** for at least 2 seconds to return to normal mode.

Notes

- Press  to return to the previous mode.
- Pressing and holding  for at least 2 seconds will return to normal mode.
- If no operation is performed for 60 seconds, the unit will return to normal mode automatically.



Setting the Time to automatically Adjust

When you set to ON, the time is automatically adjusted by RDS data.



- 1 Press and hold **AUDIO/SETUP** for at least 2 seconds to activate the **SETUP** selection mode.
- 2 Turn the **Rotary encoder** to select "TUNER", and then press **Q/ENTER**.
- 3 Turn the **Rotary encoder** to select "AUTO CLOCK", and then press **Q/ENTER**.
- 4 Turn the **Rotary encoder** to select **A-CLOCK ON** or **A-CLOCK OFF**.

- 5 Press and hold **AUDIO/SETUP** for at least 2 seconds to return to normal mode.

Notes

- Press  to return to the previous mode.
- Pressing and holding  for at least 2 seconds will return to normal mode.
- If no operation is performed for 60 seconds, the unit will return to normal mode automatically.

Receiving Traffic Information

- 1 Press and hold **BAND/TA** for at least 2 seconds so that the "TA" indicator lights up.
- 2 Press  or  to select your desired traffic information station.

When a traffic information station is tuned in, the "TP" indicator lights up.

Traffic information is heard only when it is being broadcast. If traffic information is not being broadcast, the unit is set in the standby mode. When a traffic information broadcast begins, the unit automatically receives it and mute the audio source (CD, FM radio, USB AUDIO, etc.). The display shows "TRF-INFO" for 2 seconds.

When the traffic information broadcast is over, the unit will automatically set in the standby mode.

Notes

- If you do not want to listen to the traffic information being received, lightly press **BAND/TA** to skip that traffic information message. The TA mode will remain in the ON position to receive the next traffic information message.
- If the volume level is changed while receiving traffic information, the changed volume level will be memorized. When traffic information is received next time, the volume level will be automatically adjusted to the level memorized.
- In the TA mode, the SEEK tuning selects only the TP stations.

Displaying Radio Text

Text messages from a radio station can be displayed.

Press **VIEW** while receiving FM in the radio mode to select the Radio Text display.

The display will change every time the button is pressed.

If there is PS (Programme Service Name):

PS (Programme Service Name)* → RADIO TEXT → CLOCK → PS (Programme Service Name)

* If **VIEW** is pressed and held for at least 2 seconds while displaying PS in the radio mode, frequency will be displayed for 5 seconds.

If there is no PS (Programme Service Name):

FREQUENCY → RADIO TEXT → CLOCK → FREQUENCY

The display shows "WAITING" for a few seconds, then starts scrolling the text message.

Note

- If there is no receivable text message or the unit cannot receive a text message properly, the display shows "NO TEXT".

CD/MP3

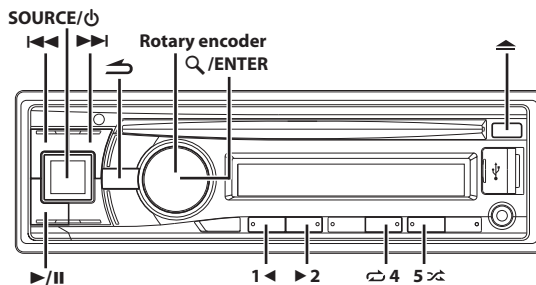





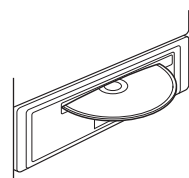





Playback

- 1 Insert a disc with the label side facing up.
The disc will be pulled into the unit automatically.





Note

- When a disc is already inserted, press **SOURCE/⏻** to switch to the DISC mode.

- 2 While playing back MP3, press  or  to select the desired folder.
Pressing and holding  or  will change folders continuously.
- 3 Press  or  to select the desired track (file).
Pressing and holding  or  will fast backward/fast forward track continuously.
- 4 To pause playback, press .
Pressing  again will resume playback.
- 5 To eject the disc, press .





Notes

- Do not remove a CD during its eject cycle. Do not load more than one disc at a time. A malfunction may result from doing either.
- The  indicator lights up when a disc is inserted.
- Three-inch (8 cm) CDs can not be used.
- Any file protected by DRM (Digital Rights Management) copy protection, cannot be played back on this unit.
- The track display for MP3 data playback is the file numbers recorded on the disc.
- The playback time may not be correctly displayed when a VBR (Variable Bit Rate) recorded file is played back.
- During CD/MP3 playback, press , and then you can quickly return to the hierarchy level selected last time in the search mode.

Repeat Play

1 Press 4.

The song is played back repeatedly.

*1 →  *2 → (off) → 

*1 Only a track/file is repeatedly played back.

*2 Only files in a folder are repeatedly played back. (MP3 mode only)

2 To cancel repeat play, select (off) with the above procedure.

M.I.X. (Random Play)

1 Press 5 .

The songs are played back in random sequence.

*1 →  *2 → **ALL** *3/*4 → (off) → 

*1 The tracks are played back in random sequence. (CD mode only)

*2 Only files in a folder are played back in random sequence. (MP3 mode only)

*3 The files in the disc are played back in random sequence. (MP3 mode only)

*4 In the USB mode, all files stored in the USB Memory are played back in random sequence.

2 To cancel M.I.X. play, select (off) with the above procedure.

Searching for CD Text

On discs utilizing CD Text, songs can be searched and played by using their recorded titles. For discs without CD Text, searches are made using the track numbers associated with each song.

1 Press /ENTER during play.

This will set the search mode, and the “Q” indicator lights up.

2 Turn the Rotary encoder to select the desired track, and then press /ENTER.

This will play the selected track.

Notes

- Press  in the search mode to cancel. Or, the search mode is cancelled if no operation is performed for 10 seconds.
- When CD Text Search is made during M.I.X. play, the M.I.X. play mode will be cancelled.

Folder/File Name Search (concerning MP3)

Folder and file names may be searched and displayed during playback.

Folder Name Search mode

1 During MP3 playback, press /ENTER to activate the search mode.



The “Q” indicator lights up.

2 Turn the Rotary encoder to select Folder Name Search mode, and then press /ENTER.

3 Turn the Rotary encoder to select the desired folder.

4 Press and hold /ENTER for at least 2 seconds to play back the first file in the selected folder.

Notes

- Press and hold  for at least 2 seconds in the search mode to cancel. Or, the search mode is cancelled if no operation is performed for 10 seconds.
- To search for files in the Folder Name Search mode, press  /ENTER. Files in the folder may be searched.
- Press  to exit Folder Name Search mode in step 3 in order to select File Name Search mode.
- The root folder is displayed as “ROOT”.
- When Folder Name Search is made during M.I.X. play, the M.I.X. play mode will be cancelled.

File Name Search mode

1 During MP3 playback, press /ENTER to activate the search mode.



The “Q” indicator lights up.

2 Turn the Rotary encoder to select File Name Search mode, and then press /ENTER.

3 Select the desired file by turning the Rotary encoder.

4 Press /ENTER to play back the selected file.

Notes

- Press and hold  for at least 2 seconds in the search mode to cancel. Or, the search mode is cancelled if no operation is performed for 10 seconds.
- Press  in the search mode to return to the previous mode.
- When File Name Search is made during M.I.X. play, the M.I.X. play mode will be cancelled.
- Press **1** ◀ or ▶ **2** to select another Folder.

About MP3

⚠ CAUTION

Except for private use, duplicating audio data (including MP3 data) or distributing, transferring, or copying it, whether for free or for a fee, without permission of the copyright holder is strictly prohibited by the Copyright Act and by international treaty.

What is MP3?

MP3, whose official name is "MPEG Audio Layer 3," is a compression standard prescribed by the ISO, the International Standardization Organization and MPEG which is a joint activity institution of the IEC. MP3 files contain compressed audio data. MP3 encoding is capable of compressing audio data at extremely high ratios, reducing the size of music files to as much as one-tenth their original size. This is achieved while still maintaining near CD quality. The MP3 format realises such high compression ratios by eliminating the sounds that are either inaudible to the human ear or masked by other sounds.

Method for creating MP3 files

Audio data is compressed using software with MP3 codecs. For details on creating MP3 files, refer to the user's manual for that software. MP3 files that are playable on this device have the file extensions "mp3". Files with no extension cannot be played back.

Supported playback sampling rates and bit rates

MP3

Sampling rates: 48 kHz, 44.1 kHz, 32 kHz, 24 kHz, 22.05 kHz, 16 kHz, 12 kHz, 11.025 kHz, 8 kHz

Bit rates: 8 - 320 kbps

This device may not play back correctly depending on sampling rates.

ID3 tags

This device supports ID3 tag v1 and v2.

If tag data is in an MP3 file, this device can display the title (track title), artist name, and album name ID3 tag data.

This device can only display single-byte alphanumeric characters (up to 30 for ID3 tags) and the underscore. For non-supported characters, "NO SUPPORT" is displayed.

If information contains characters other than ID3 tag information, the audio file may not be played back.

The tag information may not be correctly displayed, depending on the contents.

Producing MP3 discs

MP3 files are prepared, then written to a CD-R or CD-RW using CD-R writing software. A disc can hold up to 509 files/folders (including Root Folders), and the maximum number of folders is 255.

Playback may not be performed if a disc exceeds the limitations described above.

Media supported

The media that this device can play back are CD-ROMs, CD-Rs, and CD-RWs.

Corresponding File Systems

This device supports discs formatted with ISO9660 Level 1 or Level 2. Under the ISO9660 standard, there are some restrictions to remember. The maximum nested folder depth is 8 (including the root directory). The number of characters for a folder/file name is limited.

Valid characters for folder/file names are letters A-Z (all caps), numbers 0-9, and '_' (underscore).

This device also can play back discs in Joliet, Romeo, etc., and other standards that conform to ISO9660. However, sometimes the file names, folder names, etc., are not displayed correctly.

Formats supported

This device supports CD-ROM XA, Mixed Mode CD, Enhanced CD (CD-Extra) and Multi-Session.

This device cannot correctly play back discs recorded with Track At Once or packet writing.

Order of files

Files are played back in the order that the writing software writes them to the disc. Therefore, the playback order may not be what is expected. Verify the writing order in the software's documentation. The playback order of the folders and files is as follows.

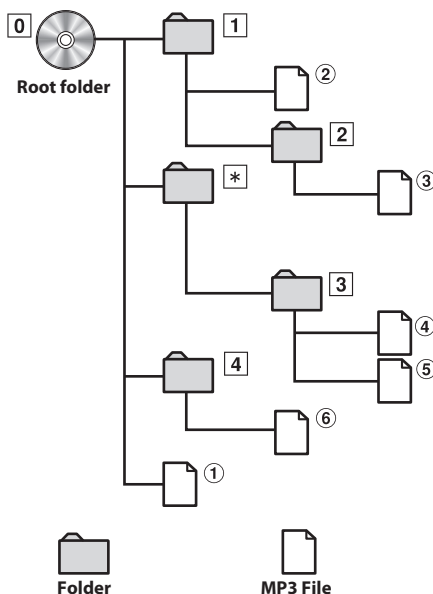

* The folder No./ folder Name will not be displayed if no file is contained in the folder.

Terminology

Bit rate

This is the "sound" compression rate specified for encoding. The higher the bit rate, the higher the sound quality, but also the larger the files.

Sampling rate

This value shows how many times per second the data is sampled (recorded). For example, music CDs use a sampling rate of 44.1 kHz, so the sound is sampled (recorded) 44,100 times per second. The higher the sampling rate, the higher the sound quality, but also the larger the volume of data.

Encoding

Converting music CDs, WAVE (AIFF) files, and other sound files into the specified audio compression format.

Tag

Song information such as track titles, artist names, album names, etc., written into MP3 files.

Root folder

The root folder (or root directory) is found at the top of the file system. The root folder contains all folders and files. It is created automatically for all burned discs.

Sound Setting

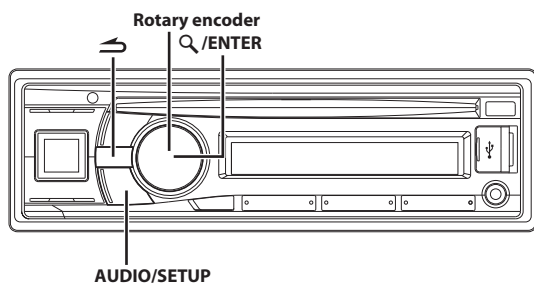

Adjusting Subwoofer Level/Bass Level/ Middle Level/Treble Level/Balance (Between Left and Right)/Fader (Between Front and Rear)/Loudness/Defeat

- 1 Press **AUDIO/SETUP** repeatedly to choose the desired mode.

Each press changes the mode as follows:

SUBWOOFER*¹ → BASS LEVEL*² → MID LEVEL*² → TRE LEVEL*² →
BALANCE → FADER → LOUDNESS*^{2/3} → DEFEAT → VOLUME →
SUBWOOFER

*1 When the subwoofer mode is set to OFF, its level cannot be adjusted.

*2 Adjustable only when DEFEAT is OFF.

*3 For details about loudness, refer to "Turning Loudness On/Off" on page 17.

Subwoofer	+0 ~ +15
Bass level	-7 ~ +7
Middle level	-7 ~ +7
Treble level	-7 ~ +7
Balance	L15 ~ R15
Fader	R15 ~ F15
Loudness	ON/OFF
Defeat	ON/OFF
Volume	0 ~ 35

Note

- If no operation is performed for 5 seconds, the unit automatically returns to normal mode.

- 2 Turn the **Rotary encoder** until the desired sound is obtained in each mode.

By setting DEFEAT ON, previously adjusted settings of BASS, MID, TRE LEVEL and LOUDNESS will return to the factory defaults.

Audio Setup

You can flexibly customize the unit to suit your own preference and usage. From the AUDIO SETUP menu, Audio Setting can be modified.

Use steps 1 to 5 to select one of the setting modes to modify. See the applicable section below for details about the selected setting item.

- 1 Press and hold **AUDIO/SETUP** for at least 2 seconds to activate the **SETUP** mode.
- 2 Turn the **Rotary encoder** to select **AUDIO**, and then press **Q/ENTER**.
AUDIO ↔ GENERAL ↔ DISPLAY ↔ TUNER ↔ iPod ↔
BLUETOOTH*¹
*1 CDE-133BT only.
- 3 Turn the **Rotary encoder** to select the desired sound setting menu, and then press **Q/ENTER**.
FACTORY EQ*^{2/3} ↔ LOUDNESS*² ↔ 3BAND EQ*^{2/4} ↔ VOL LV ADJ
↔ HPF*² ↔ SUBWOOFER ↔ SUBW LPF*^{2/5} ↔ SUBW PHASE*⁵ ↔
SUBW SYS*⁵ ↔ POWER IC
(e.g. Select SUBWOOFER)
*2 Adjustment cannot be performed when DEFEAT is set to ON.
*3 The FACTORY EQ's setting value and 3BAND EQ's setting value are linkage.
*4 The FACTORY EQ's setting value and 3BAND EQ's setting value are linkage. In step 3, three sound adjustment items (Bass, Mid and Treble) can be selected in 3BAND EQ mode, turn the **Rotary encoder** to select the desired item, and then press **Q/ENTER** to continue to step 4.
*5 These functions are inoperable when Subwoofer is set to OFF.
- 4 Turn the **Rotary encoder** to change the setting, and then press **Q/ENTER**.
(e.g. Select SUBW ON or SUBW OFF)
- 5 Press and hold **AUDIO/SETUP** for at least 2 seconds to return to normal mode.

Notes

- Pressing ↶ returns to the previous Sound menu mode.
- Pressing and holding ↶ for at least 2 seconds will return to normal mode.
- If no operation is performed for 60 seconds, Sound menu mode is cancelled.

Equalizer Presets (F-EQ)

10 typical equalizer settings are preset at the factory for a variety of musical source material.

- **Setting item:** FACTORY EQ

Setting contents:

USER / FLAT (Initial setting) / POPS / ROCK / NEWS / JAZZ /
ELEC DANCE / HIP HOP / EASY LIS / COUNTRY / CLASSICAL

Turning Loudness On/Off

Loudness introduces a special low-and high-frequency emphasis at low listening levels. This compensates for the ear's decreased sensitivity to bass and treble sound.

■ **Setting item:** LOUDNESS

Setting contents:
OFF (Initial setting) / ON

Adjusting the Parametric Equalizer Curve (3BAND EQ)

You can modify the Equalizer settings to create a response curve more appealing to your personal taste. The setting of Bass, Mid and Treble can be adjusted in this mode.

■ **Setting item:** 3BAND EQ

■ **Further setting items:** BASS / MID / TREBLE

Setting the Bass Control

1 After selecting BASS from the 3BAND EQ adjustment mode, turn the **Rotary encoder** to select the desired Bass setting item, and then press **Q/ENTER**.

WIDTH (Q) ↔ CENTER FRQ ↔ LEVEL

2 Turn the **Rotary encoder** to select the desired setting value, and then press **Q/ENTER**.

3 Press **↶** to return to the previous step.

■ **Setting the Bass Bandwidth (WIDTH (Q))**

Turn the **Rotary encoder** to select the desired bass bandwidth.

WIDE 0.50 ↔ MEDIUM 1.00 ↔ MEDIUM 1.50 ↔ NARROW 2.00

Changes the boosted bass bandwidth to wide or narrow. A wider setting will boost a wide range of frequencies above and below the centre frequency. A narrower setting will boost only frequencies near the centre frequency.

■ **Setting the Bass Centre Frequency (CENTER FRQ)**

Turn the **Rotary encoder** to select the desired bass centre frequency.

60 (Hz) ↔ 80 (Hz) ↔ 100 (Hz) ↔ 120 (Hz)

Emphasises the displayed bass frequency ranges.

■ **Setting the Bass Level**

Turn the **Rotary encoder** to select the desired bass level (-7~+7)*.

You can emphasise or weaken the bass level.

* The adjustment can also be made by pressing **AUDIO**. Refer to "Adjusting Subwoofer Level/Bass Level/Middle Level/Treble Level/Balance (Between Left and Right)/Fader (Between Front and Rear)/Loudness/Defeat" on page 16.

Setting the Mid Control

1 After selecting MID from the 3BAND EQ adjustment mode, turn the **Rotary encoder** to select the desired Mediant setting item, and then press **Q/ENTER**.

WIDTH (Q) ↔ CENTER FRQ ↔ LEVEL

2 Turn the **Rotary encoder** to select the desired setting value, and then press **Q/ENTER**.

3 Press **↶** to return to the previous step.

■ **Setting the Mid Bandwidth (WIDTH (Q))**

Turn the **Rotary encoder** to select the desired Mid bandwidth.

WIDE 0.75 ↔ MEDIUM 1.00 ↔ MEDIUM 1.25 ↔ NARROW 1.50

■ **Setting the Mid Centre Frequency (CENTER FRQ)**

Turn the **Rotary encoder** to select the desired Mid centre frequency.

500 (Hz) ↔ 1.0k (Hz) ↔ 1.5k (Hz) ↔ 2.5k (Hz)

■ **Setting the Mid Level**

Turn the **Rotary encoder** to select the desired Mid level (-7 ~ +7)*.

You can emphasise or weaken the Mid level.

* The adjustment can also be made by pressing **AUDIO**. Refer to "Adjusting Subwoofer Level/Bass Level/Middle Level/Treble Level/Balance (Between Left and Right)/Fader (Between Front and Rear)/Loudness/Defeat" on page 16.

Setting the Treble Control

1 After selecting TREBLE from the 3BAND EQ adjustment mode, turn the **Rotary encoder** to select the desired Treble setting item, and then press **Q/ENTER**.

WIDTH (Q) ↔ CENTER FRQ ↔ LEVEL

2 Turn the **Rotary encoder** to select the desired setting value, and then press **Q/ENTER**.

3 Press **↶** to return to the previous step.

■ **Setting the Treble Bandwidth (WIDTH (Q))**

Turn the **Rotary encoder** to select the desired treble bandwidth.

WIDE 0.75 ↔ NARROW 1.25

■ **Setting the Treble Centre Frequency (CENTER FRQ)**

Turn the **Rotary encoder** to select the desired treble centre frequency.

7.5K (Hz) ↔ 10.0K (Hz) ↔ 12.5K (Hz) ↔ 15.0K (Hz)

■ **Setting the Treble Level**

Turn the **Rotary encoder** to select the desired treble level (-7~+7)*.

You can emphasise or weaken the treble level.

* The adjustment can also be made by pressing **AUDIO**. Refer to "Adjusting Subwoofer Level/Bass Level/Middle Level/Treble Level/Balance (Between Left and Right)/Fader (Between Front and Rear)/Loudness/Defeat" on page 16.

Balance (Between Left and Right)/Fader (Between Front and Rear)/Loudness/Deafeat” on page 16.

Setting the Source Volume Level

The output level of each source is individually adjustable. For example, if the TUNER level sounds lower than CD, its output can be adjusted without affecting the other sources.

The Hands free phone talk level, ring tone level and microphone gain level can also be adjusted by using this setting (CDE-133BT only).

■ **Setting item:** VOL LV ADJ

■ **Further setting items:** TUNER / DISC / USB / iPod / BT AUDIO* / AUX / PHONE TALK* / RING TONE* / MIC GAIN*

Setting contents:

-5dB ~ +5dB

* CDE-133BT only.

Adjusting the High Pass Filter

The High Pass Filter on this unit can be adjusted to suit your personal taste.

■ **Setting item:** HPF

Setting contents:

OFF (Initial setting) / 60 (Hz) / 80 (Hz) / 120 (Hz) / 160 (Hz)

All frequencies above the selected cutoff are output.

Turning Subwoofer ON/OFF

When the subwoofer is on, you can adjust the subwoofer output level (refer to “Adjusting Subwoofer Level/Bass Level/Middle Level/Treble Level/Balance (Between Left and Right)/Fader (Between Front and Rear)/Loudness/Deafeat” on page 16).

■ **Setting item:** SUBWOOFER

Setting contents:

OFF (Initial setting) / ON

OFF:

No subwoofer signal is output from the Subwoofer RCA Connectors (refer to “Connections” on page 39).

ON:

The subwoofer signal is output from the Subwoofer RCA Connectors (refer to “Connections” on page 39).

Adjusting the Low Pass Filter

The Low Pass Filter on this unit can be adjusted to suit your personal taste.

■ **Setting item:** SUBW LPF

Setting contents:

OFF (Initial setting) / 60 (Hz) / 80 (Hz) / 120 (Hz) / 160 (Hz)

All frequencies lower than the selected cutoff are output.

Setting the Subwoofer Phase

The subwoofer output phase is toggled SUBWOOFER NORMAL (0°) or SUBWOOFER REVERSE (180°). To adjust the level, turn the **Rotary encoder**.

■ **Setting item:** SUBW PHASE

Setting contents:

NORMAL (Initial setting) / REVERSE

Setting the Subwoofer System

When the subwoofer is on, you can select either SYS 1 or SYS 2 for the desired subwoofer effect.

■ **Setting item:** SUBW SYS

Setting contents:

SUBW SYS 1 / SUBW SYS 2 (Initial setting)

SUBW SYS 1:

Subwoofer level changes according to the main volume setting.

SUBW SYS 2:

Subwoofer level change is different from the main volume setting. For example, even at low volume settings, the subwoofer is still audible.

External Device

Connecting to an External Amplifier (POWER IC)

When an external amplifier is connected, sound quality can be improved by stopping the power supply of the built-in amplifier.

■ **Setting item:** POWER IC

Setting contents:

ON (Initial setting) / OFF

ON:

The speakers are driven by the built-in amplifier.

OFF:

Use this mode when the line output of this unit is used to drive an external amplifier. In this setting, the head unit's internal amplifier is turned OFF and cannot drive speakers.

ON:

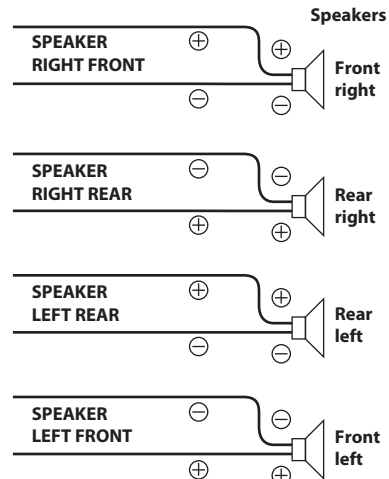

OFF:

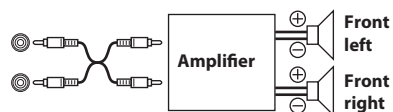

Note

- No sound is produced by the system when the power output is set to OFF.

Other Functions

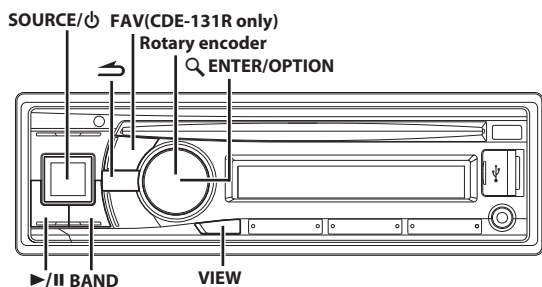

Displaying the Text

Text information, such as the disc name and the track name, will be displayed if playing a CD text compatible disc. It is also possible to display the folder name, the file name and the tag, etc., while playing MP3 files.

Press VIEW.

The display will change every time the button is pressed.

Note

- When the TEXT SCR is set to SCR MANU, press and hold VIEW for at least 2 seconds, the current text will be scrolled one time (except Radio mode).

The display in Radio mode:

If there is PS (Programme Service Name)

PS (Programme Service Name) → RADIO TEXT → CLOCK → PS (Programme Service Name)

If there is no PS (Programme Service Name)

FREQUENCY → RADIO TEXT → CLOCK → FREQUENCY

The display in CD mode:

TRACK NO./ELAPSED TIME → TEXT (DISC NAME)^{*1} → TEXT (TRACK NAME)^{*1} → TRACK NO./CLOCK → TRACK NO./ELAPSED TIME

The display in MP3 mode:

FILE NO./ELAPSED TIME → FOLDER NO./FILE NO. → FOLDER NAME → FILE NAME → ARTIST NAME^{*2} → ALBUM NAME^{*2} → SONG NAME^{*2} → FILE NO./CLOCK → FILE NO./ELAPSED TIME

The display in iPod mode:

TRACK NO./ELAPSED TIME → ARTIST NAME → ALBUM NAME → SONG TITLE → TRACK NO./CLOCK → TRACK NO./ELAPSED TIME

The display in BLUETOOTH Audio mode (CDE-133BT only):

BT A/ELAPSED TIME^{*3} → ARTIST NAME → ALBUM NAME → SONG NAME → BT A/CLOCK → BT A/ELAPSED TIME

^{*1} Displayed during playback of a disc with CD text.

^{*2} ID3 tag

If an MP3 file contains ID3 tag information, the ID3 tag information is displayed (e.g., song name, artist name, and album name). All other tag data is ignored.

^{*3} Depending on the connected mobile phone, the elapsed time may not be displayed.

About the indication display

When displaying Text, the following indicators are lit according to the mode.

Indicator/ Mode	CD Mode	MP3 Mode	iPod/iPhone/BT AUDIO ^{*4} Mode
	—	Folder Name ^{*2} being displayed	—
	—	Artist Name ^{*1} being displayed	Artist Name ^{*1} being displayed
	Text (Disc Name ^{*3}) being displayed	Album Name ^{*1} being displayed	Album Name ^{*1} being displayed
	Text (Track Name ^{*3}) being displayed	Song Name ^{*1} / File Name being displayed	Song Name ^{*1} being displayed

*1 Tag information:

If there is no tag information, "ARTIST"/"ALBUM"/"SONG" is displayed.

*2 The root folder is displayed as "ROOT".

*3 If there is no Text (Disc Name or Track Name), "DISC TEXT"/"TRACK TEXT" is displayed.

*4 CDE-133BT only.

About "Text"

Text compatible CDs contain text information such as the disc name and track name. Such text information is referred to as "text".

Notes

- Some characters may not be displayed correctly with this device, depending on the character type.
- "NO SUPPORT" is displayed if text information is not supported by the unit.
- The text or tag information may not be correctly displayed, depending on the contents.

Using the Front AUX Input Terminal

Connect a portable music player, etc. by simply connecting it to the input on the front panel. An optional adapter cable is required (standard RCA to 3.5ø mini-phono plug or 3.5ø to 3.5ø mini phono plug).

Press SOURCE/⏻, and select the AUXILIARY mode to listen to the portable device.

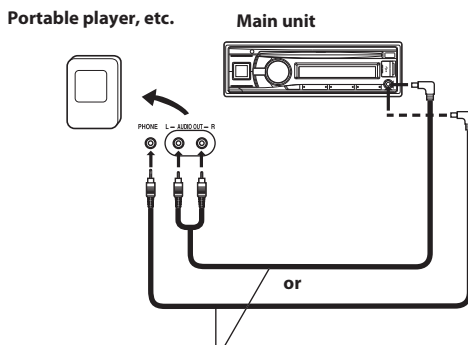

Optional adapter cable (RCA pin plugs [red, white] 3.5ø miniplugs) or (3.5ø miniplugs).

Notes

- This function is available only when AUX SETUP is set to ON. For details, refer to "Setting the AUX SETUP Mode" on page 21.
- If a USB Memory is directly connected to the USB terminal, the size or shape may interfere with driving operations, therefore, avoid connecting an AUX input terminal and a USB Memory at the same time.

Setting your favourite source to the FAV button (FAV SETUP) (CDE-131R only)

You can set a favourite source to the FAV button by following steps. Once this is set, you can switch to favourite source directly by pressing FAV.

Set your favourite source

- 1 Press and hold FAV for at least 2 seconds to activate FAV setup mode.
- 2 Turn the Rotary encoder to select a favourite source, and then press **Q** /ENTER.
The favourite source is set.
USB ↔ FM1 ↔ FM2 ↔ FM3 ↔ LW ↔ MW ↔ AUX ↔ DISC ↔ FAV OFF

Notes

- You can also set the favourite source in SETUP mode, refer to "Setting your favourite source to the FAV button (FAV SETUP) (CDE-131R only)" on page 21.
- If you do not want to use this function, select "FAV OFF".
- If no operation is performed for 10 seconds, the unit automatically returns to normal mode.
- Pressing **↶** will return to normal mode.

Recall your favourite source

Once a source is set to FAV button, press FAV to recall the source directly.

Note

- Depending on the setting, even though you set a source to FAV, it may not be available. For example, when you set AUX as your favourite source and OFF is set in "Setting the AUX SETUP Mode" (refer to "Setting the AUX SETUP Mode" on page 21), the AUX source will not be recalled by pressing FAV.

Option Menu Setting

You can quickly adjust the setting items relevant to the current SOURCE by using Option Menu.

- 1 Press and hold **Q** /ENTER/OPTION for at least 2 seconds to activate the Option menu of the current source.
Note
 - The option menu varies depending on the source.
- 2 Turn the Rotary encoder to select the desired setting item, and then press **Q** /ENTER.

- 3 Turn the Rotary encoder to change the setting, and then press **Q** /ENTER.

After the setting, the display will return to the current source automatically.

Setting item:

TUNER mode:

TUNER SET*1 ↔ VOL LV ADJ*2 ↔ DIMMER*3

DISC mode:

CD SET*4 ↔ VOL LV ADJ*2 ↔ DIMMER*3

USB mode:

VOL LV ADJ*2 ↔ DIMMER*3

iPod mode:

iPod CONT*5 ↔ iPod SET*6 ↔ VOL LV ADJ*2 ↔ DIMMER*3

AUX mode:

AUX SET*7 ↔ VOL LV ADJ*2 ↔ DIMMER*3

BT AUDIO mode (CDE-133BT only):

BT SET*8 ↔ VOL LV ADJ*2 ↔ DIMMER*3

Phone mode (Non-calling mode) (CDE-133BT only):

PHONE SET*9 ↔ VOL LV ADJ*10 ↔ DIMMER*3

Phone mode (Calling mode) (CDE-133BT only):

SPK SWITCH*11 ↔ VOICE MUTE*12 ↔ CALL WAIT*13 ↔ CALL SOUND*14 ↔ END CALL*15 ↔ VOL LV ADJ*10 ↔ DIMMER*3

*1 The setting items are the same as TUNER setting in SETUP mode. For details, refer to "SETUP" on page 21.

*2 You can individually emphasize or weaken the volume level of the current source to create your own tonal preference. The setting values in Option mode and in SETUP mode are linkage. Refer to "Setting the Source Volume Level" on page 18.

*3 Refer to "Dimmer Control" on page 22.

*4 PLAY MODE can be selected in this mode. For details, refer to "Playing MP3 Data (PLAY MODE)" on page 22.

*5 Refer to "Setting the iPod Control" on page 31.

*6 The setting items are the same as iPod setting in SETUP mode. For details, refer to "iPod/iPhone Setting" on page 22.

*7 AUX NAME can be selected in this mode. For details, refer to "Setting the AUX SETUP Mode" on page 21.

*8 FW VERSION can be selected in this mode. You can see the current firmware version about BLUETOOTH by using this setting.

*9 CALL SOUND, SENDER ID, PB UPDATE, BT MENU, PB ORDER, AUTO ANS, SEV NAME, SPEAKER SL and FW VERSION can be selected in this mode. For details about these settings, refer to "BLUETOOTH SETUP" on page 23.

*10 The Hands free phone talk level, ring tone level and microphone gain level can be adjusted by using this setting. The setting values in Option mode and in SETUP mode are linkage. Refer to "Setting the Source Volume Level" on page 18.

*11 While calling, the call sound can be switched between the unit and mobile phone by using this setting. This operation can also be done by pressing **BAND**. Refer to "Call Switching Operation" on page 29.

*12 While calling, and the Voice Mute is activated, the microphone input will mute instantly and "VOICE MUTE" will blink. This operation can also be done by pressing **▶/II**. Refer to "Muting the microphone input quickly (Voice Mute)" on page 29.

*13 If there is a waiting call, select this item to display the caller's Name and waiting number (1 or 2). Press **VIEW** and the display will switch.

*14 Refer to "Setting the BLUETOOTH sound quality" on page 25.

*15 Select this item to hang up the call.

SETUP

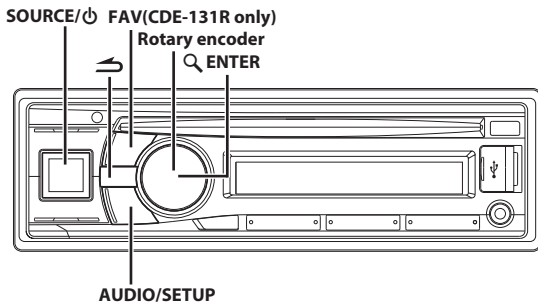

Setting

You can flexibly customize the unit to suit your own preferences and usage. From the SETUP menu, GENERAL Setting, DISPLAY Setting, etc., can be modified.

Use steps 1 to 5 to select one of the SETUP modes to modify. See the applicable section below for details about the selected SETUP item.

- 1 Press and hold AUDIO/SETUP for at least 2 seconds to activate the SETUP mode.**
- 2 Turn the Rotary encoder to select the desired item, and then press Q/ENTER.**

(e.g. Select GENERAL)

AUDIO*¹ ↔ GENERAL ↔ DISPLAY ↔ TUNER ↔ iPod ↔ BLUETOOTH*²

GENERAL:
CLOCK ADJ*³ ↔ FAV SETUP*⁴ ↔ CYRILLIC ↔ AUX SETUP ↔ AUX NAME*⁵ ↔ INT MUTE*⁶ ↔ PLAY MODE ↔ DEMO

DISPLAY:
ILLUM ↔ DIMMER ↔ SCROLLTYPE

TUNER:
AF*⁷ ↔ REGIONAL*⁸ ↔ PI SEEK*⁹ ↔ AUTO CLOCK*¹⁰

iPod:
iPod LIST

*¹ Refer to "Audio Setup" on page 16.
*² CDE-133BT only. Refer to "BLUETOOTH SETUP" on page 23.
*³ Refer to "Setting Time" on page 10.
*⁴ CDE-131R only. This can also be set in "Set your favourite source to the FAV button (FAV SETUP)" (refer to "Setting your favourite source to the FAV button (FAV SETUP) (CDE-131R only)" on page 21).
*⁵ Displayed only when AUX SETUP is set to ON.
*⁶ CDE-131R only.
*⁷ Refer to "Turning AF (Alternative Frequencies) ON/OFF" on page 12.
*⁸ Refer to "Receiving RDS Regional (Local) Stations" on page 12.
*⁹ Refer to "PI SEEK Setting" on page 12.
*¹⁰ Refer to "Setting the Time to automatically Adjust" on page 12.
- 3 Turn the Rotary encoder to select a setting item, and then press Q/ENTER.**

(e.g. Select AUX SETUP)

- 4 Turn the Rotary encoder to change the setting, and then press Q/ENTER.**

(e.g. Select AUX ON or AUX OFF.)
- 5 Press and hold AUDIO/SETUP for at least 2 seconds to return to normal mode.**

Notes

- Press ↶ to return to the previous mode.
- Pressing and holding ↶ for at least 2 seconds will return to normal mode.
- If no operation is performed for 60 seconds, the unit will return to normal mode automatically.

General Setting

GENERAL is selected on the setup main menu in step 2.

Setting your favourite source to the FAV button (FAV SETUP) (CDE-131R only)

You can select one source as your favourite source. Once this is set, you can switch to favourite source directly by pressing FAV.

Setting item: FAV SETUP

Setting contents:

USB / FM1 / FM2 / FM3 / LW / MW / AUX / DISC / FAV OFF
(Initial setting)

Notes

- Depending on the setting, some item may not selectable.
- If you do not want to use this function, select "FAV OFF".
- This setting can also be activated by pressing and holding FAV for at least 2 seconds. For details, refer to "Setting your favourite source to the FAV button (FAV SETUP) (CDE-131R only)" on page 21.

Setting the Language (CYRILLIC)

Set the language to be displayed on the unit.

Setting item: CYRILLIC

Setting contents:

OFF (Initial setting) / ON

OFF:

English, Latin character

ON:

Russian, English

Setting the AUX SETUP Mode

You can input the audio of an external device, (such as a Portable audio player) to the AUX connector of this unit.

Setting item: AUX SETUP

Setting contents:

AUX OFF / AUX ON (Initial setting)

AUX OFF:

When set to OFF, AUX source cannot be selected.

AUX ON*:

Set to ON when a portable device is connected. If SOURCE/⏻ is pressed and AUX is selected, the sound of the portable device is input to the unit.

* You can change the AUX NAME display when AUX SETUP is set to ON. Press Q/ENTER when AUX SETUP is set to ON, and select AUX NAME by turning the Rotary encoder, then press Q/ENTER. After that, turn the Rotary encoder to select the desired AUX NAME.

Note

- When the PORTABLE is set, PMD is displayed on the unit.

Turning Mute Mode On/Off (INT MUTE) (CDE-131R only)

If a device having the interrupt feature is connected, audio will be automatically muted whenever the interrupt signal is received from the device.

Setting item: INT MUTE

Setting contents:

OFF AUX (Initial setting) / ON

OFF AUX:

When the interrupt signal is received from device, the AUX source volume will be output from the unit.

ON:

When the interrupt signal is received from device, no sound will be output.

Playing MP3 Data (PLAY MODE)

This unit can play back CDs containing both CD and MP3 data (created in Enhanced CD (CD Extra) format). However, in some situations, playback of an enhanced CD may be difficult. In this case, you can select playback of a single session only, containing the CD data. When a disc contains both CD and MP3 data, playback starts from the CD data portion of the disc.

Setting item: PLAY MODE

Setting contents:

CD-DA / CDDA/MP3 (Initial setting)

CD-DA:

Only the CD data in Session 1 can be played back.

CDDA/MP3:

CD data, MP3 files in mixed mode, and multi-session discs can be played back.

Note

- Perform this setting before inserting a disc. If a disc has already been inserted, remove it first.

Demonstration

This unit has a demonstration feature for the display.

Setting item: DEMO

Setting contents:

DEMO OFF (Initial setting) / DEMO ON

Note

- To quit Demo mode, set to DEMO OFF.

Display Setting

DISPLAY is selected on the setup main menu in step 2.

Changing Lighting Colour

You can change the lighting colour of the buttons of this unit.

Setting item: ILLUM

Setting contents:

ILLUM TYPE1 (Initial setting) / TYPE2 / TYPE3 / TYPE4

TYPE1:

When the colour of SOURCE /  button is blue, the colour of the other is red.

TYPE2:

When the colour of SOURCE /  button is green, the colour of the other is green.

TYPE3:

When the colour of SOURCE /  button is amber, the colour of the other is red.

TYPE4:

When the colour of SOURCE /  button is red, the colour of the other is red.

Dimmer Control

Set the Dimmer control to AUTO to decrease the illumination brightness of the blue button with the head lights of the vehicle ON. This mode decreases the unit's backlighting at a certain extent at night.

Setting item: DIMMER

Setting contents:

DIM MANUAL / DIM AUTO (Initial setting)

Note

- The setting is available only when the ILLUM setting is ILLUM TYPE1. For details, refer to "Changing Lighting Colour" on page 22.

Scroll Setting (SCROLLTYPE)

This CD player can scroll the disc and track names recorded on CD-TEXT discs, as well as the text information of MP3 files, folder names and tags.

Setting item: SCROLLTYPE

Setting contents:

SCR MANUAL / SCR AUTO (Initial setting)

SCR MANUAL:

The display is scrolled when a disc is loaded or when a track is changed, etc.

SCR AUTO:

The current text information of CD, folder, tag, etc. is scrolled automatically.

Note

- The unit scrolls CD text names, folder names, file names or tag display.

iPod/iPhone Setting

"iPod" is selected on the setup main menu in step 2.

iPod/iPhone Search Mode Setting

The unit allows you to search for the iPod/iPhone using eight different search modes.

Setting item: iPod LIST

Further setting items: PLAYLISTS / ARTISTS / ALBUMS / AUDIOBOOKS / PODCASTS / GENRES / COMPOSERS / SONGS

Setting contents:

OFF / ON

Notes

- When the search mode is in Playlists/Artists/Albums/Podcasts/Genres/Songs, the initial setting is On, and when the search mode is in Audiobooks/Composers, the initial setting is Off.
- For search mode details, refer to "Searching for a desired Song" on page 32.

BLUETOOTH Operation (CDE-133BT only)

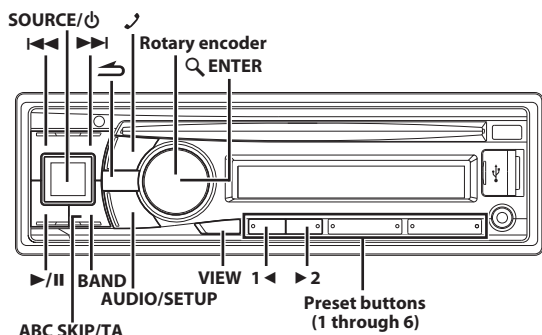

Setup Before Using

About BLUETOOTH

BLUETOOTH is a wireless technology allowing communication between a mobile device or personal computer over short distances. This enables a hands-free call or data transmission between BLUETOOTH compatible devices. BLUETOOTH transmission is available in the unlicensed 2.4 GHz spectrum if the distance between devices is within 10 meters. For details, refer to the BLUETOOTH Home page (<http://www.bluetooth.com>).

Notes

- Depending on the BLUETOOTH version, a BLUETOOTH compatible device may not be able to communicate with this unit.
- Proper function of this unit with all BLUETOOTH compatible devices is not guaranteed. For handling of the BT compatible device, consult your ALPINE dealer or ALPINE website.
- Depending on the surroundings, BLUETOOTH wireless connection may be unstable.
- When you place a call, or perform setup operations, be sure to stop your car in a safe place.
- Depending on the connected BLUETOOTH compatible device(s), the function may differ. Also refer to the Owner's Manual of the connected device(s).
- When you search this unit using the BLUETOOTH compatible phone, the unit name is displayed as "Alpine CD Receiver" model name.

Before Using BLUETOOTH Function

Before using the BLUETOOTH function, the following settings need to be made.

Set "HFP" or "AUDIO" to ON when you want to use Hands-Free phone or BT Audio function. Refer to "Setting the BLUETOOTH Connection (BT IN)" on page 24.

Note

- Before using BLUETOOTH function, it must be paired with this unit. Refer to "How to connect to a BLUETOOTH compatible device (Pairing)" on page 23.

How to connect to a BLUETOOTH compatible device (Pairing)

For details on the control from a BLUETOOTH compatible device, refer to the Owner's Manual of the BLUETOOTH compatible device.

Pairing a BLUETOOTH compatible device with SSP (Secure Simple Pairing)

- Using your BLUETOOTH compatible device, select the "Alpine CD Receiver" for pairing.
- Turn the Rotary encoder to change the head unit display from "PAIR NO" to "PAIR YES".
If "PAIR NO" is selected, the connection will be cancelled.
- If the pairing was successful, "CONNECTED" is displayed for a few seconds. The head unit then returns to its previous state.

Pairing a BLUETOOTH compatible device without SSP (Secure Simple Pairing)

- Using your BLUETOOTH compatible device, select the Alpine CD Receiver for pairing.
- Input the PIN code ("0000") in a BLUETOOTH compatible device.
Note
 - The PIN code is fixed as "0000".
- If the pairing was successful, "CONNECTED" is displayed for a few seconds. The head unit then returns to its previous state.

Notes

- If the connection is unsuccessful, "FAILED" is displayed.
- After a successful pairing, the two devices should re-pair automatically whenever the vehicle's ignition is turned ON. However, the re-pairing may fail. If the auto re-pairing fails, try to pair manually.
- Set "VISIBLE M" to VISI M ON to enable this unit to be recognised by a BLUETOOTH compatible device, refer to "Setting the Visible Mode" on page 24.
- You can also manually pair the BLUETOOTH devices from this unit. For details, refer to "Pairing a BLUETOOTH Device from the unit" on page 24.

BLUETOOTH SETUP

The following steps 1 to 5 are common to the various BLUETOOTH functions. For details, refer to each individual function.

Note

- Set "HFP" or "AUDIO" to ON, and then perform BLUETOOTH SETUP operation. Refer to "Setting the BLUETOOTH Connection (BT IN)" on page 24.

- Press and hold AUDIO/SETUP for at least 2 seconds to activate the SETUP mode.
- Turn the Rotary encoder to select "BLUETOOTH", and then press Q/ENTER.
The BLUETOOTH setup mode is activated.

Note

- The BLUETOOTH setup mode can also be activated by pressing and holding  for at least 2 seconds.

3 Turn the Rotary encoder to select the desired items and then press /ENTER.

BLUETOOTH:

BT IN*1 ↔ PAIRED DEV ↔ VISIBLE M*1 ↔ SEARCH DEV*1 ↔
CALL SOUND*2 ↔ SENDER ID*2 ↔ PB UPDATE*2 ↔ BT MENU*2
↔ PB ORDER*2 ↔ AUTO ANS*2 ↔ SEV NAME*2 ↔ SPEAKER SL*2
↔ FW VERSION ↔ FW UPDATE*1

*1 The items are not displayed during a phone call.



*2 The items are not displayed if "HFP" is set to OFF. Refer to "Setting the BLUETOOTH Connection (BT IN)" on page 24.

4 Turn the Rotary encoder to change the settings.

5 Press and hold AUDIO/SETUP for at least 2 seconds.

The SETUP mode is cancelled.

Notes

- Press  to return to the previous mode.
- Pressing and holding  for at least 2 seconds will return to normal mode.
- If no operation is performed for 60 seconds, the unit will return to normal mode automatically.

Setting the BLUETOOTH Connection (BT IN)

With BLUETOOTH technology, you can place a hands-free call by a BLUETOOTH-equipped mobile phone. Audio information of a BLUETOOTH compatible mobile phone, a portable audio player, etc., is controllable/playable wirelessly from this unit.

Setting item: BT IN

Further setting items: HFP / AUDIO

Setting contents:

OFF / ON (Initial setting)

Hands-Free Phone setting (HFP)



ON:

Select when you want to pair your BLUETOOTH compatible phone with this unit.

OFF:

Hands-Free Phone function is not used.

Note

- When HFP is set to OFF, the indicators related to Hands-free phone (, battery quantity, , signal strength and , message) will not be displayed.

BLUETOOTH Audio setting (AUDIO)

ON:

Select when you want to use BLUETOOTH Audio function.

OFF:

BLUETOOTH Audio function is not used.

Setting the BLUETOOTH Device

Select one of 3 connected BLUETOOTH compatible devices that you previously registered.







Setting item: PAIRED DEV

1 Turn the Rotary encoder to select a BLUETOOTH compatible device you want to use (you want to change connection) and then press /ENTER.

2 Turn the Rotary encoder to select "CONNECT" to connect the selected device.

The connected device is marked with "▲". Select "DISCONNECT" to disconnect this device. Select "CLEAR" when you want to clear the device from the device list.

Notes

- If the connection is successfully changed, "CONNECTED" is displayed for 2 seconds and the  indicator lights up, then the display returns to the SETUP screen.
- If a mobile phone is connected to this unit successfully, the  indicator lights up to show the battery quantity of the connected mobile phone. The  indicator lights up when the battery quantity is in middle level, and it blinks in low level.
- Indicator  (Signal Strength): The indicator will display the current signal strength of mobile phone. The indicator blinks when the signal of the connected mobile phone is weak.
- Depending on the connected mobile phone, the  (battery quantity),  (signal strength) and  (message) indicators may not be displayed.
- If all the 3 positions have been registered, you cannot register the 4th device. To register another device, you need to delete one of the devices from position 1 to 3 first.

Setting the Visible Mode

You can set whether this unit can be recognised or not from a BLUETOOTH compatible device. Normally set this to VISI M ON.

Setting item: VISIBLE M

Setting contents:

VISI M ON (Initial setting) / VISI M OFF

VISI M ON:

Enable recognition of this unit from the BLUETOOTH compatible device.

VISI M OFF:

Disable recognition of this unit from the BLUETOOTH compatible device.

Pairing a BLUETOOTH Device from the unit

The BLUETOOTH device is used when a connectable BLUETOOTH compatible device is searched and connected to this unit, or when a new BLUETOOTH compatible device is registered.

Setting item: SEARCH DEV

1 When SEARCH DEV is selected, and "SEARCHING" is displayed, the search gets started.

Note

- The "SEARCHING" operation can be stopped by pressing .

2 Turn the Rotary encoder to select the name of the device to be connected from the Device Search list and then press /ENTER.

- 3** If this unit is successfully connected to a BLUETOOTH compatible device, "CONNECTED" is displayed, and then the unit returns to normal mode.

Depending on the mobile phone, it may be necessary to input a passcode. In this case, "CODE 0000" is displayed. Input the passcode "0000" in the BLUETOOTH compatible device to make the pairing. After the pairing is completed, the unit will automatically connect to the BLUETOOTH compatible device. If you input the wrong passcode or the communication fails, "FAILED" is displayed.

Setting the BLUETOOTH sound quality

You can flexibly customize the sound of call to fit your own preferences.

■ **Setting item:** CALL SOUND

■ **Further setting items:** VOL LV ADJ / AUTO SET

Adjusting the volume (VOL LV ADJ)

You can emphasize or weaken the volume level of the Phone call, the ring tone and the microphone input to fit your own preferences.

Setting contents:

PHONE TALK:
-5 ~ +5 db

RING TONE:
-5 ~ +5 db

MIC GAIN:
-5 ~ +5 db

Note

- These setting items are the same as PHONE TALK, RING TONE and MIC GAIN settings in AUDIO step mode, refer to "Setting the Source Volume Level" on page 18.

Sound Auto setting (AUTO SET)

This unit provides 5 methods to improve the sound quality of calling. You can choose the type according to your own preference.

Setting contents:

TYPE1 (Initial setting) / TYPE2 / TYPE3 / TYPE4 / TYPE5

TYPE1:
Standard Mode (recommended)

TYPE2:
Enhances the noise reduction

TYPE3:
Enhances the echo-cancel

TYPE4:
Enhances both noise reduction and echo-cancel

TYPE5:
Weakens both noise reduction and echo-cancel

Notes

- The functions below are designed to improve the sound quality of the caller to driver.
Noise reduction: This function can reduce the road noise, but excessive enhancement may affect the sound quality of calling.
Echo-cancel: This function can reduce the echo noise, but excessive enhancement may affect the sound quality of calling.
- Improvement effect differs depending on the actual calling environment, so please choose a suitable type accordingly.

Setting the caller information display/text message indicator ON/OFF

You can choose whether to use these functions according to the following setting.

■ **Setting item:** SENDER ID

■ **Further setting items:** MSG ALERT / CALLER ID

Setting contents:

ON (Initial setting) / OFF

Setting text message indicator ON/OFF (MSG ALERT)

When it is set to ON, the indicator blinks for 30 seconds while receiving a text message. The indicator remains on if there is an unread text message on the connected mobile phone.

Notes

- Depending on the mobile phone, this function may not be performed.
- The text of the text message will not be displayed on this unit.
- When this unit prompts you of a received text message, it is recommended to read the message after stopping your car in a safe place, rather than read it immediately through your phone.

Setting the caller information display ON/OFF (CALLER ID)

If you want to keep the ID information of the caller from others, set this item to OFF. While you are dialing a number, telephone name will be displayed as "ID UNSENT". While a call is dialing in or during a call, "NO NAME" will be displayed.

Phone Book Auto Update ON/OFF

You can set whether to update the phone book automatically.

■ **Setting item:** PB UPDATE

Setting contents:

ON (Initial setting) / OFF

ON:
When the mobile phone reconnects with this unit, the phone book will update.

OFF:
The phone book will not update.

Setting the BLUETOOTH Menu language

The BLUETOOTH Menu can be switched within 6 languages.

■ **Setting item:** BT MENU

Setting contents:

ENGLISH (Initial setting) / DEUTSCH / FRANCAIS / ESPANOL / ITALIANO / NEDERLANDS

Changing the Phone book List Order

The phone book is listed alphabetically according to the initial letter of name.

You can choose to arrange the phone book list order according to the initial letters of the FIRST NAME or LAST NAME.

■ Setting item: PB ORDER

Setting contents:

FIRST NAME (Initial setting) / LAST NAME

Note

- “WAITING” will be displayed while the Phone book order is switching. You can quit the “WAITING” screen to perform other operations by pressing  when the ordering is still in progress, at this time, the phone book is not accessible. In addition, the ordering may affect the playback of BT AUDIO.

Setting the Received Calls automatically (Auto Answer)

When a call is received, you can set whether to receive it automatically or not.

■ Setting item: AUTO ANS

Setting contents:

AT ANS ON / AT ANS OFF (Initial setting)

AT ANS ON:

When a call is received, it is answered automatically after about 5 seconds.

AT ANS OFF:

When a call is received, it is not answered automatically. Press  to receive the call.

Note

- If the received call setting on the mobile phone is on, the call will be answered automatically even though this setting is set to OFF.

Displaying the phone service provider name

The service provider name of the connected BLUETOOTH compatible device will be displayed. If a BLUETOOTH compatible device is not connected, “ID UNSENT” will be displayed.

■ Setting item: SEV NAME

Note

- Depending on the character type some phone service provider name cannot be displayed. “ID UNSENT” will be displayed.

Selecting the output speaker

You can select the connected speaker in car to output the sound signal of telephone.

■ Setting item: SPEAKER SL

Setting contents:

ALL (Initial setting) / FRONT-L / FRONT-R / FRONT-LR

ALL:

The sound be output from all of speakers in car.

FRONT-L:

The sound only be output from the front left speaker.

FRONT-R:

The sound only be output from the front right speaker.

FRONT-LR:

The sound be output from the front left and front right speaker.

Displaying the firmware version

The current firmware version will be displayed.

■ Setting item: FW VERSION

Updating the firmware

Future BLUETOOTH firmware updates may become available for phone interoperability.

For information to update your BLUETOOTH firmware, please visit your local Alpine web site or choose your country from Alpine Europe top page (<http://www.alpine-europe.com>).

■ Setting item: FW UPDATE

Setting contents:

UPDATE NO (Initial setting) / UPDATE YES

Hands-Free Phone Control

About the Hands-Free Phone

Hands-free calls are possible when using a HSP (Head Set Profile) and HFP (Hands-Free Profile) compatible mobile phone with this unit.

Notes

- Avoid performing a hands-free call in heavy traffic or on narrow or winding streets.
- Close the windows while calling to reduce background noise.
- If both calling parties are using hands-free devices, or the call is made in a noisy location, difficulty hearing the other person's voice is normal.
- Depending on telephone line conditions or certain mobile devices used, voices may sound unnatural.
- When using a microphone, speak as directly as you can into the microphone to pick up the best sound quality.
- Certain mobile phone features are dependent on the capabilities and settings of your service provider's network. Additionally, certain features may not be activated by your service provider, and/or the provider's network settings may limit the feature's functionality. Always contact your service provider about feature availability and functionality. All features, functionality, and other product specifications, as well as the information contained in the Owner's Manual are based upon the latest available information and are believed to be accurate at the time of printing. Alpine reserves the right to change or modify any information or specifications without notice or obligation.

Answering a Call

Incoming calls are announced by the received call ring tone and a displayed message (PHONE).

Press .

The call starts.

Notes

- When “AUTO ANS” is set to AT ANS ON, you can receive a call automatically. Refer to “Setting the Received Calls automatically (Auto Answer)” on page 26.
- While calling, the source sound on the unit is muted. After calling, playback will resume.

Hanging up the Telephone

Press .

The call finishes.

Note

- You can also hang up the call by pressing and holding  for at least 2 seconds.

Calling

Call History is recorded for the last dialed/received/missed calls (80 records for each). There are various ways of making calls based on the "Calling". The following steps 1 to 5 are common to the various ways of making these calls. For details, refer to each individual category for making calls.

1 Press .

The outgoing method list is displayed.

2 Turn the Rotary encoder to select the outgoing mode.

Setting contents:

When "BT MENU" is set to "ENGLISH".

VOICE DIAL / DIALLED / RECEIVED / MISSED / PHONE BOOK

VOICE DIAL:

Voice dial operation

DIALLED:

Dialled history

RECEIVED:

Received history

MISSED:

Missed incoming history

PHONE BOOK:

Mobile phone book

When "BT MENU" is set to "DEUTSCH".

SPRACHWAHL / GEWAEHLEHT / ANGENOMMEN / VERPASST / TEL-BUCH

When "BT MENU" is set to "FRANCAIS".

CP-VOCALE / COMPOSES / RECUS / MANQUES / REPERTOIRE

When "BT MENU" is set to "ESPAÑOL".

MARC VOCAL / REALIZADAS / RECIBIDAS / PERDIDAS / AGENDA

When "BT MENU" is set to "ITALIANO".

C VOCALE / EFFETTUAATE / RICEVUTE / PERSE / RUBRICA

When "BT MENU" is set to "NEDERLANDS".

VOICE DIAL / GEKOZEN / ONTVANGEN / GEMISTE / TEL BOEK

Note

- For details, refer to "Setting the BLUETOOTH Menu language" on page 25.

3 Press .

The outgoing mode is activated, and each mode list is displayed.

Note

- It may take some time for the list to be displayed, and also directly after connection, the list may not be brought up to date.



4 Turn the Rotary encoder to select a name or a telephone number from the list.

Note

- You can use Phone book alphabet search function to search a name or number from Phone Book. For details, refer to "Phone book alphabet search function" on page 28.

5 Press .

The selected telephone will be called.

If one name has several numbers registered in the telephone book, press  /ENTER after selecting the name*, then turn the **Rotary encoder** to choose the desired number and press  /ENTER, the telephone will be called. Press and hold  /ENTER for at least 2 seconds after selecting the name, the default number of the name will be called. Depending on the connected mobile phone, this function may not be performed.

* If the name cannot be recognized, default number will be displayed.

Notes

- Press  to return to the previous mode.
- If no operation is performed for 60 seconds, the unit will return to normal mode automatically.
- The names registered in the telephone book are displayed. If the name is not registered, a number is displayed. If both name and number cannot be displayed, "ID UNSENT" will be displayed.
- If you place a call directly from the paired mobile phone, the phone number is not displayed, you cannot redial from the unit in this case.

Voice Dial Operation

You can make a call using voice commands.

Setting item: VOICE DIAL

When the speak mode is activated and "SPEAK" is displayed, say the telephone number*, name* you want to call into the microphone.

* This message depends on the voice tag prestored in the mobile phone.

Notes

- You can perform this operation only when a voice dial compatible mobile phone is connected. If the mobile phone is not compatible with the voice dial, "NO SUPPORT" is displayed for 2 seconds.
- The Voice Dial function performance depends on the recognition range of the mobile phone and mounting location of the microphone. Please pay attention when the microphone is mounted.
- Voice dial operation depends on the function of the mobile phone. For details, refer to the Owner's Manual of the mobile phone.
- If a called person that you say is not found, "NO CALL" is displayed for 2 seconds.

Redialing a Number In Outgoing History

Previously dialed telephone numbers are stored in dialed calls history. You can redial a number by searching from dialed calls history.

Setting item: DIALLED

Dialing a Number In Incoming History

Telephone numbers from received calls are stored in the Received List. You can redial these numbers by searching here.

Setting item: RECEIVED

Dialing a Number In Incoming Missed Call History

Telephone numbers for received calls that are missed, are stored in the Missed List. You can redial these numbers by searching here.

Setting item: MISSED

Dialing a Number In The Phone Book

Up to 1,000 names (at most 5 telephone numbers for each name) are downloadable from a mobile phone. Dial a call by selecting a person from the phone book list.

■ Setting item: PHONE BOOK

Notes

- The order of the list display depends on the setting of "PB ORDER" (refer to "Changing the Phone book List Order" on page 26).
- If the call history or phone book of the mobile phone is added or deleted while it is connected to the unit, the list displayed on the unit may not be brought up to date. If it is not updated, you cannot correctly place a call.
- You can display the information of a number stored in phone book by pressing **VIEW**. Each press changes the display as Name → Telephone NO. → Telephone label* → Name
If the information can not be obtained, "NO NAME", "NO NUMBER" or "NO LABEL" will display.

* The telephone label of a number depends on the number information stored in Phone book of the mobile phone, which includes 5 types-GENERAL, MOBILE, HOME, OFFICE, and OTHER.

Phone book alphabet search function

You can select the first three letters to search for a desired name in phone book list by using the Phone book alphabet search function.

For example:

Searching a name "Michael James"

The following example explains how the search is performed.

Depending on the setting in PB ORDER (refer to "Changing the Phone book List Order" on page 26), the phone book is listed in first name or last name order. Please search for the first name or last name according to the setting.

- 1 Press **ABC SKIP/TA** while in the phone book list, the phone book alphabet search mode is activated.

The letter selection list is displayed.

- 2 Turn the **Rotary encoder** to select the first letter (e.g. M), and then press **▶▶I**.

The letter selection list is displayed.

- 3 Turn the **Rotary encoder** to select the second letter (e.g. I), and then press **▶▶I**.

The letter selection list is displayed.

- 4 Turn the **Rotary encoder** to select the third letter (e.g. C), and then press **Q/ENTER**.

The names stored in phone book which begin with "MIC" are searched.

- 5 Turn the **Rotary encoder** to select the desired name (e.g. Michael James), and then press **Q/ENTER** to make the call.

Notes

- If the selected name has several numbers registered in phone book, you need to turn the **Rotary encoder** to select the desired number, and then press **Q/ENTER**.
- Press **◀◀** in step 3 or 4 to delete the current entry and return to the previous step.
- You can search for a name by its first letter, first two letters or first three letters. Press **Q/ENTER** after entering the desired number of letters. A list displays the names beginning with the entered letter(s).

Call waiting function

If a second call is received during a current call, you can have the first caller wait momentarily while you take the second call. When you are finished with one call, you can switch to the other one.

If a second call is received during the current call (call1), the information of second caller (call2) is displayed instead of the current caller's name. Press ▶ 2, the call waiting mode is activated.

In this case, call1 is on hold, while you take call2.

Notes

- In the call waiting mode, press **1 ◀** or **▶ 2** to switch between the calling person and the person on hold.
- In the call waiting mode, press and hold **1 ◀** or **▶ 2** for at least 2 seconds to hang up call1 or call2, and the other call will be answered automatically.
- In the call waiting mode, you can press **VIEW** to change the display between waiting number (1or 2) and caller name.

Preset a number in the Phone Book (Shortcut dial)

Assign numbers that you dial frequently to presets for quick recall. You can assign up to six frequently called phone numbers to number presets.

Select a number you want to preset from the Phone Book list. Press and hold any one of the preset buttons (1 through 6) as the one that you wish to store the number for at least 2 seconds.

The phone number you selected is stored in presets.

Notes

- If the name has several numbers registered in the phone book, press **Q/ENTER** after selecting the name. Turn the **Rotary encoder** to choose the desired number. Press and hold any one of the **preset buttons (1 through 6)** for at least 2 seconds. The selected number is stored as a preset number.
- A total of 18 phone numbers can be stored in the preset memory (6 numbers for each mobile phone in the paired device list). If a mobile phone is deleted from the paired device list, the stored preset numbers of this mobile phone are deleted, even when it is paired again.
- If you store a phone number in a preset with a previously stored number, the current number will be cleared and replaced by the new one.

Dialing the preset number

- 1 Press any one of the **preset buttons (1 through 6)** that has had a number stored in the phone mode.

The information (name/number) stored in the preset station is displayed.

- 2 Press **Q/ENTER** or **↵**.

The stored preset number is dialed directly.

Adjusting the volume when receiving a Call

While calling, you can adjust the volume.

Turn the Rotary encoder to adjust the volume.

Note

- You may need to increase volume from your regular audio listening source level. However, increasing the volume excessively may result in feedback. Feedback is directly related to the volume. Turning down the volume as low as acceptable, will reduce it. Positioning the microphone in a direction away from the main car speakers (e.g. clipped on sun visor) may also reduce feedback at high volume.

Muting the microphone input quickly (Voice Mute)

While calling, activating the Voice Mute function will instantly mute the microphone input. Your voice will not be heard by the caller.

While calling, press ►/II to mute the microphone input.

Press ►/II again will bring the microphone input back to its previous volume level.

Note

- The operation can also be performed in the option menu of phone mode (calling mode). Refer to "Option Menu Setting" on page 20.

Call Switching Operation

While making a call, this function allows you to initiate the transfer of the audio between the mobile phone and the speakers in the car.

While calling, press BAND to switch the call sound between the unit and mobile phone.

Notes

- Depending on the mobile phone, this operation may not be performed.
- The operation can also be performed in the option menu of phone mode (calling mode). Refer to "Option Menu Setting" on page 20.

BLUETOOTH Audio Operation

Audio information of a BLUETOOTH compatible mobile phone, a portable player, etc., is controllable/playable wirelessly* from this unit.

* To play back audio, a mobile phone or a portable player conforming to A2DP (Advanced Audio Distribution Profile) and AVRCP (Audio/Video Remote Control Profile) is required.

Not all functions work with all devices.

Notes

- Set "AUDIO" to ON when you want to use BLUETOOTH Audio function. Refer to "Setting the BLUETOOTH Connection (BT IN)" on page 24.
- During a call, sound on the BLUETOOTH audio source is muted.
- If you operate the Hands-free phone (e.g. searching in the phonebook) while using the BLUETOOTH Audio function, BLUETOOTH Audio playback may be affected.

Recalling the BLUETOOTH Audio Mode

Press SOURCE/🔊 to select the BT AUDIO mode.

Selecting the desired Song

Press I◀◀.

Returns the beginning of the song being played back.

Press ►►I.

Forwards the next song.

Pausing

Press ►/II.

A playback stops. Touching again will resume a playback.

USB Memory (optional)

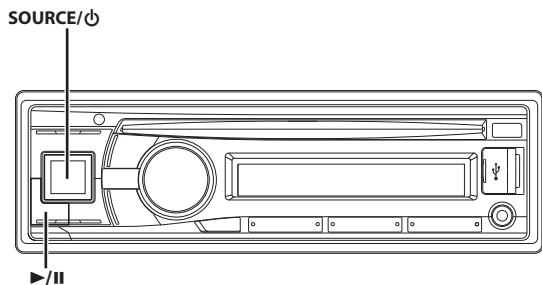

Playing MP3 Files from USB Memory (optional)

If you connect a USB memory containing MP3, MP3 files can be played back.

- 1 Press **SOURCE/⏻** to switch to the USB AUDIO mode.
- 2 To pause playback, press **▶/||**.
Pressing **▶/||** again will resume the playback.

Notes

- The root folder is displayed as "ROOT" in the Folder Name Search mode.
- This unit plays back files in the USB Memory with the same controls and modes as playback of CDs containing MP3. For details, refer to "CD/MP3" on page 13.
- Before disconnecting USB Memory, be sure to change to another source or set to pause.
- The playback time may not be correctly displayed when a VBR (Variable Bit Rate) recorded file is played back.

USB Memory Connection (optional)

Connect USB Memory

- 1 Open the cover of the USB Port.
- 2 Connection the USB Memory directly to the USB Port, or via the USB cable.

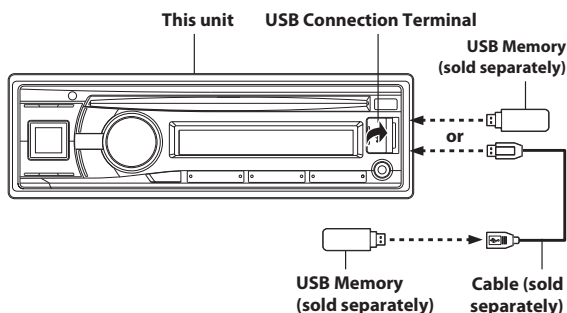

Remove USB Memory

- 1 Carefully, pull out the USB Memory Device from the USB cable or the USB Port.
- 2 Close the cover of the USB Port.

Notes

- Change to a source other than the USB Memory mode, then remove the USB Memory Device. If USB Memory is removed in the USB Memory mode, data may be damaged.
- When removing USB Memory, pull it out straight.
- If sound is not output or USB Memory is not recognized even when connected, remove the USB Memory Device once, and then connect it again.
- Route the USB cable away from other cables, etc.
- After removing the USB Memory, close the cover of the USB Port to prevent dust or foreign objects from entering and causing a malfunction.

About MP3 File of USB Memory

Playing back MP3

MP3 files are prepared, then stored to a USB Memory Device. This unit can recognise at most 100 folders and 100 files per folder stored in USB Memory. Playback may not be performed if a USB Memory Device exceeds the limitations described above. Do not make a file's playback time more than 1 hour.

Media supported

This device can play back USB Memory.

Corresponding File Systems

This device supports FAT 12/16/32 for USB Memory device.

iPod/iPhone (optional)

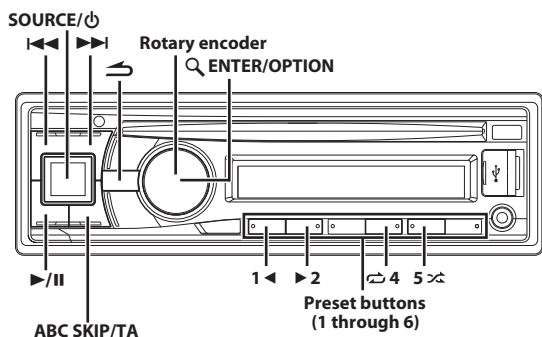

Connecting an iPod/iPhone

An iPod/iPhone can be connected to this unit by using the Interface cable for iPod (included with iPod). When an iPod/iPhone is connected to this unit, you can choose to control the iPod/iPhone using its own controls or by the head unit controls. For details, refer to “Setting the iPod Control” on page 31.

These instructions refer to controlling the iPod/iPhone from this Head Unit (HU) only. Make sure iPod Control is set to HU (HEAD UNIT). Refer to “Setting the iPod Control” on page 31. Refer to the iPod/iPhone manual for operations using the iPod/iPhone.

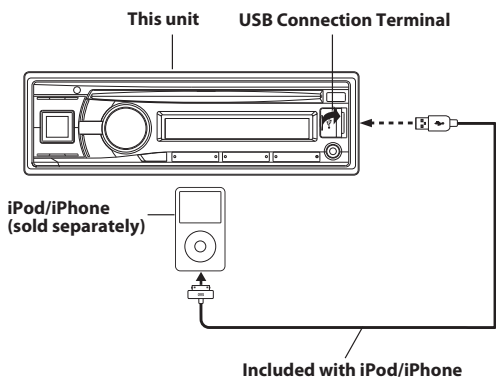

Notes

- An iPhone connected to this unit operates as an iPod. The iPhone can be used as a hands-free device using the integrated Bluetooth module.
- Internet and telephone functions of iPod touch or iPhone, etc., can also be used when connecting to the unit. However, using these functions will stop or pause the playing songs, at this time do not operate the unit to avoid a malfunction.
- Do not leave an iPod/iPhone in a car, as its mechanism is sensitive to high temperature and humidity conditions, and damage may result.

About iPod/iPhone models usable with this unit

- Confirmed devices regarding Made for iPod. Correct function of earlier versions cannot be guaranteed.

iPod touch (4th generation): Ver.4.3
 iPod nano (6th generation): Ver.1.0
 iPod touch (3rd generation): Ver.4.3
 iPod nano (5th generation): Ver.1.0.2
 iPod classic (160 GB) (Late 2009): Ver.2.0.4
 iPod touch (2nd generation): Ver.4.2.1

iPod nano (4th generation): Ver.1.0.4
 iPod classic (120 GB): Ver.2.0.1
 iPod touch (1st generation): Ver.3.1.3
 iPod nano (3rd generation): Ver.1.1.3
 iPod classic (80 GB, 160 GB): Ver.1.1.2
 iPod nano (2nd generation): Ver.1.1.3
 iPod with video: Ver.1.3

- iPod nano (1st generation): Ver.1.3.1
- Confirmed devices regarding Made for iPhone. Correct function of earlier versions cannot be guaranteed.
- iPhone 4: Ver.4.3
- iPhone 3GS: Ver.4.3
- iPhone 3G: Ver.4.2.1
- iPhone: Ver.3.1.3
- For clarity in identifying your model of iPod, please see Apple’s own document “Identifying iPod models” at <http://support.apple.com/kb/HT1353>
- This unit does not support video playback from iPod/iPhone, even using a video-compatible cable.

Setting the iPod Control

When an iPod/iPhone is connected, operate it from its own controls or from the head unit.

- 1 Press and hold **Q /ENTER/OPTION** for at least 2 seconds in the iPod mode.

The Option menu for iPod mode is activated.

- 2 Turn the **Rotary encoder** to select iPod CONT, and then press **Q /ENTER**.

The iPod control mode will switch between iPod MODE and HU MODE.

HU (HEAD UNIT):

Operate the iPod/iPhone via this unit.

iPod:

Operate the iPod/iPhone using its own controls. When iPod is selected, some functions will not be operable via the head unit.

Notes

- Once the control mode is changed, this will set pause status, press **▶/||** to continue.
- Depending upon the iPod used, iPod control may not be selectable. Or, if iPod is selected, operation must still be from the head unit.

Playback

- 1 Press **SOURCE/⏻** to switch to the iPod mode.

- 2 Press **◀◀** or **▶▶** to select the desired song.

Pressing and holding **◀◀** or **▶▶** will fast backward/fast forward the current track.

- 3 To pause playback, press **▶/||**.

Pressing **▶/||** again will resume playback.

Notes

- A song playing on the iPod/iPhone while it is connected to this unit will continue to play from where it was paused after disconnection.
- If you listen to an episode from a selected Podcast or Audiobook, the episode can be changed by pressing **1◀** or **▶2**.
- An episode may have several chapters. The chapter can be changed by pressing **◀◀** or **▶▶**.
- During iPod/iPhone playback, press **↶**, and then you can quickly return to the hierarchy level selected last time in the search mode.

Searching for a desired Song

An iPod/iPhone can contain thousands of songs. The unit for this reason can make various searches using the search function as shown below. Each music category has its own individual hierarchy. Use the Playlist/Artist/Album/Song/Podcast/Genre/Composer/Audiobook search mode to narrow searches based on the table below.

Hierarchy 1	Hierarchy 2	Hierarchy 3	Hierarchy 4
Playlist	Song	—	—
Artist*	Album*	Song	—
Album*	Song	—	—
Song	—	—	—
Podcast	Episode	—	—
Genre*	Artist*	Album*	Song
Composer*	Album*	Song	—
Audiobook	—	—	—

Note

- You can select your preferred search mode. Refer to “iPod/iPhone Search Mode Setting” on page 22.

For example:

Searching by Artist name

The following example explains how an ARTIST search is performed. Another search mode can be used for the same operation, although the hierarchy differs.

- Press **Q** / **ENTER** to activate the search selection mode. The “Q” indicator lights up.
- Turn the **Rotary encoder** to select the **ARTIST** search mode, and then press **Q** / **ENTER**.
SHUFFLE ALL*1 ↔ PLAYLIST ↔ ARTIST ↔ ALBUM ↔ SONG ↔ PODCAST ↔ GENRE ↔ COMPOSER ↔ AUDIOBOOK ↔ SHUFFLE ALL
- Turn the **Rotary encoder** to select the desired **Artist**, and then press **Q** / **ENTER**.
- Turn the **Rotary encoder** to select the desired **Album**, and then press **Q** / **ENTER**.
- Turn the **Rotary encoder** to select the desired **Song**, and then press **Q** / **ENTER**.

*1 Refer to “Random Play Shuffle (M.I.X.)” on page 33.

Note

- The display of search mode list varies depending on the setting of iPod LIST. For details, refer to “iPod/iPhone Search Mode Setting” on page 22.
- After pressing and holding **Q** / **ENTER** for at least 2 seconds while in each hierarchy (except SONG and AUDIOBOOK hierarchy), all songs of the selected hierarchy are played back.
- After selecting [ALL] in the search mode with*1, (refer to the table above) press and hold **Q** / **ENTER** for at least 2 seconds to play back all songs in the iPod/iPhone or selected search mode.
- While in the search mode, if you press and hold **↶** for 2 seconds, or no operation is performed for 10 seconds, the search mode is cancelled.
- In the search mode, pressing **↶** will return to the previous mode.
- When search is made during M.I.X. play, the M.I.X. play mode will be cancelled.
- “NO SONG” will be displayed if there are no songs in the selected playlist in the PLAYLIST search mode.

- “NO PODCAST” will be displayed if there is no podcast data in the iPod/iPhone in the PODCAST search mode.
- “NOAUDIOBOK” will be displayed if there is no audiobook data in the iPod/iPhone in AUDIOBOOK search mode.
- If “iPod name” stored in the iPod/iPhone is selected in the desired Playlist search mode, and **Q** / **ENTER** is pressed, you can search for all songs in the iPod/iPhone. Also, if you press and hold **Q** / **ENTER** for at least 2 seconds, all songs in the iPod/iPhone are played back.
- Depending on the iPod/iPhone, podcast search is not supported.
- If any one of the **preset buttons (1 through 6)** is pressed in the search mode, a search can be made quickly by skipping to the specified location. For details, refer to “Direct Search Function” on page 32.

Alphabet search function

The unit’s alphabet search function can be used to search for an album, song, etc., more efficiently. In PLAYLIST/ARTIST/ALBUM/SONG/PODCAST/GENRE/COMPOSER/AUDIOBOOK search mode, select the first letter of your desired title (album, song, etc.), the titles beginning with this letter are listed. By using this function, you can quickly target any song.

- In the search mode, press **ABC SKIP/TA**.
The letter selection list is displayed.
- Turn the **Rotary encoder** to select a desired letter (e.g. M), and then press **Q** / **ENTER**.
The titles beginning with “M” are listed.
- Turn the **Rotary encoder** to select the desired title.

Notes

- While in Alphabet search mode, pressing **↶** will return to the previous mode.
- If the PLAYLIST search mode is used to search for a song, the Alphabet search function is inactive in the song search hierarchy.

Direct Search Function

The unit’s direct search function can be used to search for an album, song, etc., more efficiently. In PLAYLIST/ARTIST/ALBUM/SONG/PODCAST/GENRE/COMPOSER/AUDIOBOOK mode, you can quickly target any song.

In the search mode, press any one of the **preset buttons (1 through 6)** to quickly skip over a designated percent of your song content.

Song search example:

If there are 100 songs in your iPod/iPhone, they are divided into 6 groups using percentages (shown below). These groups are assigned to the preset buttons (1 through 6).

Example 1:

Suppose the song you are searching for is located at around the middle (50%) of your library: press button 4 to jump to the 50th song and turn the **Rotary encoder** to find the desired song.

Example 2:

Suppose the song you are searching for is located near the end (83%) of your library: press button 6 to jump to the 83rd song and turn the **Rotary encoder** to find the desired song.

	All 100 songs (100%)					
	0%	17%	33%	50%	67%	83%
Preset buttons	1	2	3	4	5	6
Songs	1st song	17th song	33rd song	50th song	67th song	83rd song

Select Playlist/Artist/Album/Genre/Composer

Playlist/Artist/Album/Genre/Composer can be easily changed. For example, if you listen to a song from a selected album, the album can be changed.

Press 1 ◀ or ▶ 2 to select the desired Playlist/Artist/Album/Genre/Composer.

Notes

- If the song search mode was used to select a song, this function is inactive.
- If an album is selected during an artist search, other albums by that artist are searchable.
- This function is inactive during shuffle (🔀) playback.

Random Play Shuffle (M.I.X.)

The Shuffle function of the iPod/iPhone is displayed as 🔄 on this unit.

Shuffle Albums:

The songs on each album are played back in proper order. Upon completion of all the songs on the album, the next album is selected randomly. This continues until all albums have been played.

Shuffle Songs:

Song shuffle randomly plays back songs within a selected category (playlist, album, etc.). The songs within the category are played just once until all songs have been played.

1 Press 5 🔄.

The songs are played back in random sequence.

🔍 🔄*1 → 🔄*2 → (off) → 🔍 🔄

*1 Shuffle Albums.

*2 Shuffle Songs.

2 To cancel M.I.X. play, select (off) with the above procedure.

Note

- If a song is selected in the album search mode before selecting M.I.X. play, the songs will not play back randomly even when Shuffle Albums is selected.

Shuffle ALL:

Shuffle ALL plays all songs in the iPod/iPhone randomly. Any one song does not play back again until all songs have been played back.

1 Press 🔍 /ENTER to activate the search selection mode.

2 Turn the Rotary encoder to select SHUFFLE ALL, and then press 🔍 /ENTER.

The "ALL 🔄" indicator lights up.

To cancel M.I.X. play, press 5 🔄 to select OFF.

Note

- If Shuffle ALL is selected, the selected songs being played back in the search mode are cancelled.

Repeat Play

Only Repeat One is available for the iPod/iPhone.

Repeat One:

A single song is repeatedly played back.

1 Press 🔁 4.

The song is played back repeatedly.

🔁* → (off) → 🔁

* Repeat One.

2 To cancel repeat play, select (off) with the above procedure.

Note

- During repeat playback, no other songs are selectable by pressing ⏮ or ⏭.

Information

In Case of Difficulty

If you encounter a problem, please turn the power off, then on again. If the unit is still not functioning normally, please review the items in the following checklist. This guide will help you isolate the problem if the unit is at fault. Otherwise, make sure the rest of your system is properly connected or consult your authorized Alpine dealer.

Basic

No function or display.

- Vehicle's ignition is off.
 - If connected following instructions, the unit will not operate with the vehicle's ignition off.
- Improper power lead (Red) and battery lead (Yellow) connections.
 - Check power lead and battery lead connections.
- Blown fuse.
 - Check the fuse of the unit; replace with the proper value if necessary.
- Internal micro-computer malfunctioned due to interference noise etc.
 - Press the **RESET** button with a ballpoint pen or other pointed article.

Radio

Unable to receive stations.

- No antenna or open connection in cable.
 - Make sure the antenna is properly connected; replace the antenna or cable if necessary.

Unable to tune stations in the seek mode.

- You are in a weak signal area.
 - Make sure the tuner is in the DX mode.
- If the area you are in is a primary signal area, the antenna may not be grounded and connected properly.
 - Check your antenna connections; make sure the antenna is properly grounded at its mounting location.
- The antenna may not be the proper length.
 - Make sure the antenna is fully extended; if broken, replace the antenna with a new one.

Broadcast is noisy.

- The antenna is not the proper length.
 - Extend the antenna fully; replace it if it is broken.
- The antenna is poorly grounded.
 - Make sure the antenna is grounded properly at its mounting location.

CD

CD Player not functioning.

- Out of operating temperature range +50°C (+120°F) for CD.
 - Allow the vehicle's interior (or trunk) temperature to cool.

CD playback sound is wavering.

- Moisture condensation in the CD Module.
 - Allow enough time for the condensation to evaporate (about 1 hour).

CD insertion not possible.

- A CD is already in the CD player.
 - Eject the CD and remove it.

- The CD is being improperly inserted.
 - Make sure the CD is being inserted following instructions in the CD Player Operation section.

Unable to fast forward or backward the CD.

- The CD has been damaged.
 - Eject the CD and discard it; using a damaged CD in your unit can cause damage to the mechanism.

CD playback sound skips due to vibration.

- Improper mounting of the unit.
 - Securely re-mount the unit.
- The disc is very dirty.
 - Clean the disc.
- The disc has scratches.
 - Change the disc.
- The pick-up lens is dirty.
 - Do not use a commercially available lens cleaner disc. Consult your nearest Alpine dealer.

CD playback sound skips without vibration.

- The disc is dirty or scratched.
 - Clean the disc; damaged disc should be replaced.

Error displays (built-in CD player only).

- Mechanical error
 - Press **▲**. After the error indication disappears, insert the disc again. If the above-mentioned solution does not solve the problem, consult your nearest Alpine dealer.

CD-R/CD-RW playback not possible.

- Close session (finalisation) has not been performed.
 - Perform finalisation and attempt playback again.

MP3

MP3 is not played back.

- Writing error occurred. The MP3 format is not compatible.
 - Make sure the MP3 has been written in a supported format. Refer to "About MP3" on page 15, then rewrite in the format supported by this device.

Audio

The sound is not output from the speakers.

- Unit has no output signal of the internal amplifier.
 - POWER IC is switched to "POW ON"; refer to "Connecting to an External Amplifier (POWER IC)" on page 18.

iPod

iPod does not play and no sound is output.

- The iPod has not been recognised.
 - Reset this unit and the iPod. Refer to "Initial System Start-Up" on page 9. To reset the iPod, refer to the Owner's Manual of the iPod.

Indication for CD Player

NO DISC

- No CD is inserted.
 - Insert a CD.
- Although a disc is inserted, "NO DISC" is displayed and the unit does not start to play or eject the disc.
 - Remove the disc by following these steps:
 - Press the **▲** button again for at least 2 seconds.
 - If the disc still does not eject, consult your Alpine dealer.

ERROR

- Mechanism error.
 - 1 **Press the ▲ button and eject the CD.**
If not ejecting, consult your Alpine dealer.
 - 2 **When the error indication remains after ejecting, press the ▲ button again.**
If the error indication still does not turn off after pressing the ▲ button for a few times, consult your Alpine dealer.
- When "ERROR" is displayed:
If the disc cannot be ejected by pressing ▲, press the **RESET** button (Refer to "Initial System Start-Up" on page 9) and press ▲ again.
If the disc still cannot be ejected, consult your Alpine dealer.

UNSUPPORTED

- A sampling rate/bit rate not supported by the unit is used.
 - Use a sampling rate/bit rate that is supported by the unit.

Indication for USB Memory

DEVICE ERR

- A USB device that is not supported by the unit is connected.
 - Connect a USB device that is supported by the unit.

NO DEVICE

- A USB Memory is not connected.
 - Make sure the USB Memory device is correctly connected and the cable is not excessively bent.

NO FILE

- No MP3 (file) is stored in the USB Memory.
 - Connect the USB Memory device after storing songs (files).

UNSUPPORTED

- A sampling rate/bit rate not supported by the unit is used.
 - Use a sampling rate/bit rate that is supported by the unit.

NO SUPPORT

- Text information that is not recognizable by the unit has been input.
 - Use a USB Memory device with input text information that is supported by the unit.

ERROR-01

- Communication error
 - Turn the ignition key off, and then set to ON again.
 - Check the display by reconnecting between the USB Memory and this unit.

ERROR-04

- Power surge error
Excessive voltage/current is supplied to the USB Memory.
 - Try another USB Memory, if available.

Indication for iPod Mode

NO DEVICE

- The iPod/iPhone is not connected.
 - Make sure the iPod/iPhone is correctly connected (Refer to "Connections" on page 39).
Make sure the cable is not bent excessively.

NO SONG

- There are no songs in the iPod/iPhone.
 - Download songs to the iPod/iPhone and connect to this unit.

ERROR-01

- Communication error
 - Turn the ignition key off, and then set to ON again.
 - Reset the iPod.
 - Check the display by reconnecting between the iPod/iPhone and this unit, using the iPod/iPhone cable.

ERROR-02

- Caused by the iPod/iPhone Software Version not being compatible with this unit.
 - Update the iPod/iPhone Software Version to be compatible with this unit.

ERROR-03

- The iPod/iPhone is not verified.
 - Reset the iPod.
 - Try another iPod/iPhone, if available.

ERROR-04

- Power surge error
Excessive voltage/current is supplied to the iPod/iPhone.
 - Try another iPod/iPhone, if available.

BLUETOOTH mode (CDE-133BT only)

NO UNIT

- The BLUETOOTH device is not connected.
 - Connect the BLUETOOTH device.

Specifications

FM TUNER SECTION

Tuning Range	87.5~108.0 MHz
Mono Usable Sensitivity	0.7 μ V
Alternate Channel Selectivity	80 dB
Signal-to-Noise Ratio	65 dB
Stereo Separation	35 dB
Capture Ratio	2.0 dB

MW TUNER SECTION

Tuning Range	531~1,602 kHz
Sensitivity (IEC Standard)	25.1 μ V/28 dB

LW TUNER SECTION

Tuning Range	153~281 kHz
Sensitivity (IEC Standard)	31.6 μ V/30 dB

CD PLAYER SECTION

Frequency Response	5~20,000 Hz (\pm 1 dB)
Wow & Flutter (% WRMS)	Below measurable limits
Total Harmonic Distortion	0.008% (at 1 kHz)
Dynamic Range	95 dB (at 1 kHz)
Signal-to-Noise Ratio	105 dB
Channel Separation	85 dB (at 1 kHz)

USB SECTION

USB requirements	USB 1.1/2.0
Max. Power Consumption	1,000 mA
USB Class	Mass Storage
File System	FAT 12/16/32
MP3 Decoding	MPEG AUDIO Layer-3
Number of Channels	2-Channel (Stereo)
Frequency Response*	5~20,000 Hz (\pm 1 dB)
Total Harmonic Distortion	0.008% (at 1 kHz)
Dynamic Range	95 dB (at 1 kHz)
Signal-to-Noise Ratio	105 dB
Channel Separation	85 dB (at 1 kHz)

* Frequency response may differ depending on the encoder software/bit rate.

BLUETOOTH SECTION (CDE-133BT only)

BLUETOOTH Specification	BLUETOOTH V 3.0
Output Power	+4 dBm Max. (Power class 2)
Profile	HFP (Hands-Free Profile) HSP (Head Set Profile) A2DP (Advanced Audio Distribution Profile) AVRCP (Audio/Video Remote Control Profile)

PICKUP

Wave length	795 nm
Laser power	CLASS I

GENERAL

Power Requirement	14.4 V DC (11~16 V allowable)
Maximum Power Output	50 W \times 4
Maximum Pre-Output Voltage	2 V/10 k ohms
Bass	\pm 14 dB at 60 Hz
Treble	\pm 14 dB at 10 kHz
Loudness	10 dB at 100 Hz
Weight	1.5 kg (3 lbs. 4 oz)

CHASSIS SIZE

Width	178 mm (7")
Height	50 mm (2")
Depth	161 mm (6~3/8")

NOSEPIECE SIZE

Width	170 mm (6~3/4")
Height	46 mm (1~13/16")
Depth	25 mm (1")

Note

- Due to continuous product improvement, specifications and design are subject to change without notice.

CAUTION



(Bottom side of player)

Installation and Connections

Before installing or connecting the unit, please read the following and refer to "Operating Instructions" on page 6 for proper use.

WARNING

MAKE THE CORRECT CONNECTIONS.

Failure to make the proper connections may result in fire or product damage.

USE ONLY IN CARS WITH A 12 VOLT NEGATIVE GROUND.

(Check with your dealer if you are not sure.) Failure to do so may result in fire, etc.

BEFORE WIRING, DISCONNECT THE CABLE FROM THE NEGATIVE BATTERY TERMINAL.

Failure to do so may result in electric shock or injury due to electrical shorts.

DO NOT SPLICE INTO ELECTRICAL CABLES.

Never cut away cable insulation to supply power to other equipment. Doing so will exceed the current carrying capacity of the wire and result in fire or electric shock.

DO NOT DAMAGE PIPE OR WIRING WHEN DRILLING HOLES.

When drilling holes in the chassis for installation, take precautions so as not to contact, damage or obstruct pipes, fuel lines, tanks or electrical wiring. Failure to take such precautions may result in fire.

DO NOT USE BOLTS OR NUTS IN THE BRAKE OR STEERING SYSTEMS TO MAKE GROUND CONNECTIONS.

Bolts or nuts used for the brake or steering systems (or any other safety-related system), or tanks should NEVER be used for installations or ground connections. Using such parts could disable control of the vehicle and cause fire etc.

KEEP SMALL OBJECTS SUCH AS BATTERIES OUT OF THE REACH OF CHILDREN.

Swallowing them may result in serious injury. If swallowed, consult a physician immediately.

DO NOT INSTALL IN LOCATIONS WHICH MIGHT HINDER VEHICLE OPERATION, SUCH AS THE STEERING WHEEL OR SHIFT LEVER.

Doing so may obstruct forward vision or hamper movement etc. and results in serious accident.

DO NOT ALLOW CABLES TO BECOME ENTANGLED IN SURROUNDING OBJECTS.

Arrange wiring and cables in compliance with the manual to prevent obstructions when driving. Cables or wiring that obstruct or hang up on places such as the steering wheel, shift lever, brake pedals, etc. can be extremely hazardous.

CAUTION

HAVE THE WIRING AND INSTALLATION DONE BY EXPERTS.

The wiring and installation of this unit requires special technical skill and experience. To ensure safety, always contact the dealer where you purchased this product to have the work done.

USE SPECIFIED ACCESSORY PARTS AND INSTALL THEM SECURELY.

Be sure to use only the specified accessory parts. Use of other than designated parts may damage this unit internally or may not securely install the unit in place. This may cause parts to become loose resulting in hazards or product failure.

ARRANGE THE WIRING SO IT IS NOT CRIMPED OR PINCHED BY A SHARP METAL EDGE.

Route the cables and wiring away from moving parts (like the seat rails) or sharp or pointed edges. This will prevent crimping and damage to the wiring. If wiring passes through a hole in metal, use a rubber grommet to prevent the wire's insulation from being cut by the metal edge of the hole.

DO NOT INSTALL IN LOCATIONS WITH HIGH MOISTURE OR DUST.

Avoid installing the unit in locations with high incidence of moisture or dust. Moisture or dust that penetrates into this unit may result in product failure.

PRECAUTIONS

- Be sure to disconnect the cable from the (-) battery post before installing your CDE-133BT/CDE-131R. This will reduce any chance of damage to the unit in case of a short-circuit.
- Be sure to connect the colour coded leads according to the diagram. Incorrect connections may cause the unit to malfunction or damage to the vehicle's electrical system.
- When making connections to the vehicle's electrical system, be aware of the factory installed components (e.g. on-board computer). Do not tap into these leads to provide power for this unit. When connecting the CDE-133BT/CDE-131R to the fuse box, make sure the fuse for the intended circuit of the CDE-133BT/CDE-131R has the appropriate amperage. Failure to do so may result in damage to the unit and/or the vehicle. When in doubt, consult your Alpine dealer.
- The CDE-133BT/CDE-131R uses female RCA-type jacks for connection to other units (e.g. amplifier) having RCA connectors. You may need an adaptor to connect other units. If so, please contact your authorized Alpine dealer for assistance.
- Be sure to connect the speaker (-) leads to the speaker (-) terminal. Never connect left and right channel speaker cables to each other or to the vehicle body.

IMPORTANT

Please record the serial number of your unit in the space provided below and keep it as a permanent record. The serial number or the engraved serial number is located on the bottom of the unit.

SERIAL NUMBER: []
INSTALLATION DATE: []
INSTALLATION TECHNICIAN: []
PLACE OF PURCHASE: []

Installation

CAUTION

When you install this unit in your car, do not remove the detachable front panel.

If the detachable front panel is removed during installation, you might press too hard and warp the metal plate that holds it in place.

The main unit must be mounted within 35 degrees of the horizontal plane, back to front.

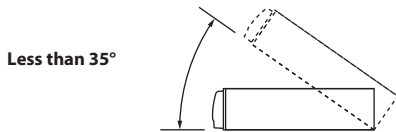

- 1 Remove the mounting sleeve from the main unit (Refer to "Removal" on page 38). Slide the mounting sleeve into the dashboard and fix it with the metal shackles.

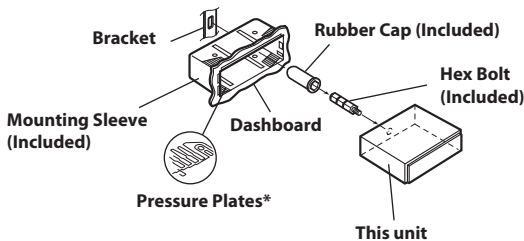

* If the installed mounting sleeve is loose in the dashboard, the pressure plates may be bent slightly to remedy the problem.

- 2 When your vehicle has the Bracket, mount the long hex bolt onto the rear panel of the CDE-133BT/CDE-131R and put the Rubber Cap on the hex bolt. If your vehicle does not have the Mounting Support, reinforce the head unit with the metal mounting strap (not supplied). Connect all the leads of the CDE-133BT/CDE-131R according to details described in the CONNECTIONS section.

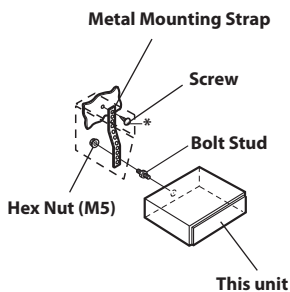

* For the screw*, provide a proper screw to the chassis installing location.

- 3 Slide the CDE-133BT/CDE-131R into the dashboard. When the unit is in place, make sure the locking pins are fully seated in the down position. This can be done by pressing firmly in on the unit while pushing the locking pin down with a small screwdriver. This ensures that the unit is

properly locked and will not accidentally come out from the dashboard. Install the detachable front panel.

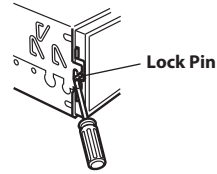

Removal

- 1 Remove the detachable front panel.
- 2 Use a small screwdriver (or similar tool) to push the locking pins to the "up" position (see above drawing). As each pin is unlocked, gently pull out on the unit to make sure it does not re-lock before unlocking the second pin.
- 3 Pull the unit out, keeping it unlocked as you do so.

JAPANESE CAR

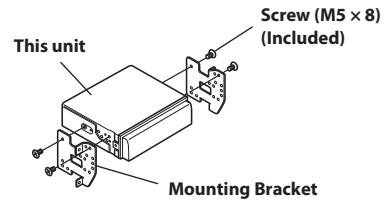
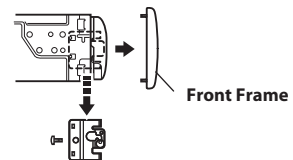

Mounting the Microphone (CDE-133BT only)

For the sake of safety, mount the microphone in the following location.

- In a stable and secure location.
- In a location that does not inhibit safely driving the vehicle.
- Mount the microphone in a location where the driver's voice can easily be picked up.

Choose a location for the microphone that can easily pick up the drivers voice. Requiring the driver to move towards the microphone for audibility causes a distraction that could be dangerous.

Connections

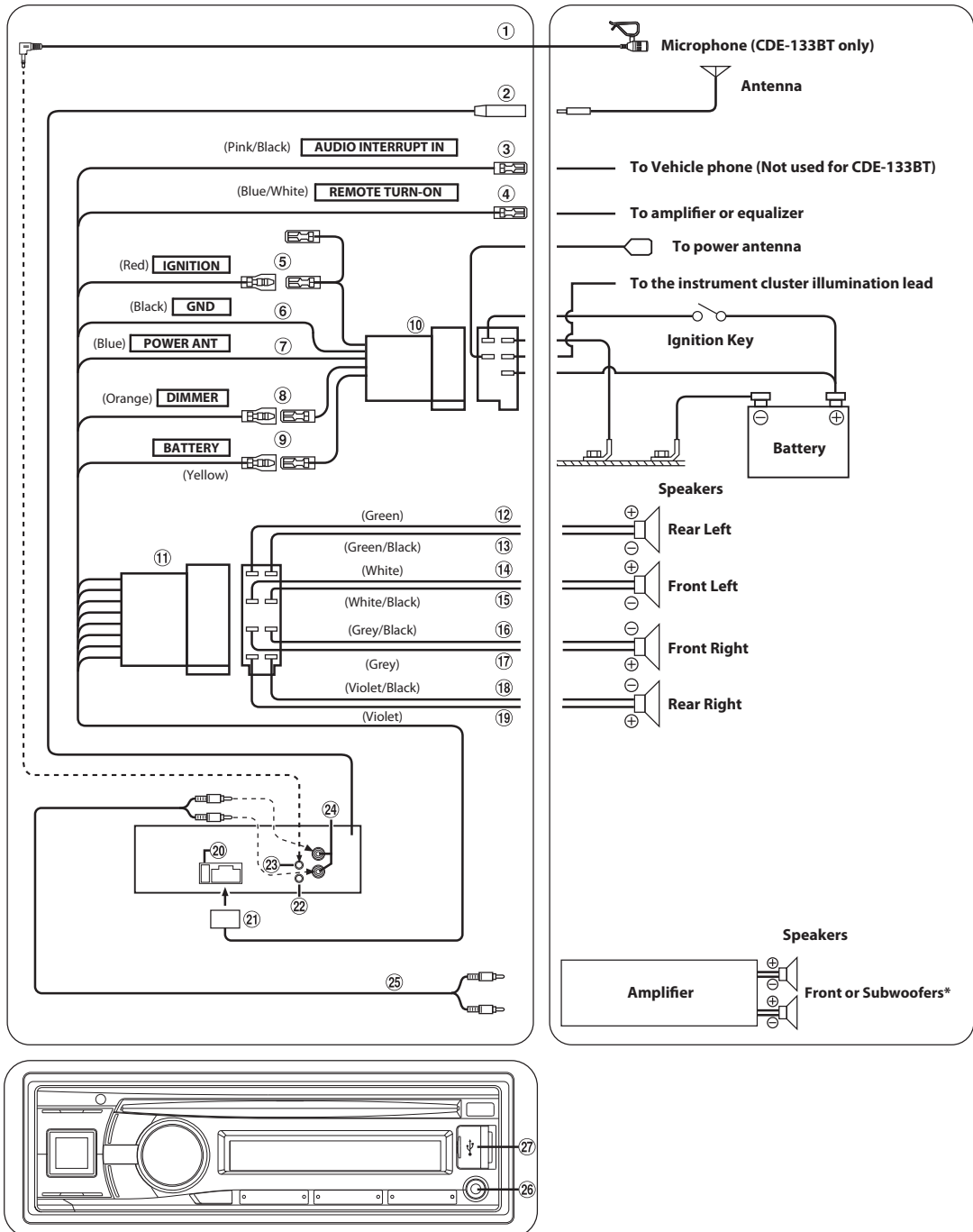

* When Subwoofer is OFF: Output is for Front speakers. When Subwoofer is ON: Output is for Subwoofer. For details on how to set the Subwoofer to ON/OFF, refer to "Turning Subwoofer ON/OFF" on page 18.

- ① **Microphone (Included with CDE-133BT)**
- ② **Antenna Receptacle**
- ③ **Audio Interrupt In Lead (Pink/Black)**
Not used for CDE-133BT.
- ④ **Remote Turn-On Lead (Blue/White)**
Connect this lead to the remote turn-on lead of your amplifier or signal processor.
- ⑤ **Switched Power Lead (Ignition) (Red)**
Connect this lead to an open terminal on the vehicle's fuse box or another unused power source which provides (+) 12V only when the ignition is turned on or in the accessory position.
- ⑥ **Ground Lead (Black)**
Connect this lead to a good chassis ground on the vehicle. Make sure the connection is made to bare metal and is securely fastened using the sheet metal screw provided.
- ⑦ **Power Antenna Lead (Blue)**
Connect this lead to the +B terminal of your power antenna, if applicable.
- Note**
- This lead should be used only for controlling the vehicle's power antenna. Do not use this lead to turn on an amplifier or a signal processor, etc.
- ⑧ **Dimmer Lead (Orange)**
This lead may be connected to the vehicle's instrument cluster illumination lead. This will enable the vehicle's dimmer control to dim the backlighting of the unit.
- ⑨ **Battery Lead (Yellow)**
Connect this lead to the positive (+) post of the vehicle's battery.
- ⑩ **ISO Power Supply Connector**
- ⑪ **ISO Connector (Speaker Output)**
- ⑫ **Left Rear (+) Speaker Output Lead (Green)**
- ⑬ **Left Rear (-) Speaker Output Lead (Green/Black)**
- ⑭ **Left Front (+) Speaker Output Lead (White)**
- ⑮ **Left Front (-) Speaker Output Lead (White/Black)**
- ⑯ **Right Front (-) Speaker Output Lead (Grey/Black)**
- ⑰ **Right Front (+) Speaker Output Lead (Grey)**
- ⑱ **Right Rear (-) Speaker Output Lead (Violet/Black)**
- ⑲ **Right Rear (+) Speaker Output Lead (Violet)**
- ⑳ **Fuse Holder (10A)**
- ㉑ **Power Supply Connector**
- ㉒ **Steering Remote Control Interface Connector**
To steering remote control interface box.
You can operate this unit from the vehicle's control unit when an Alpine Steering Remote Control Interface Box (optional) is connected. For details, contact your Alpine dealer.
- ㉓ **MIC Input Connector (CDE-133BT only)**
To Microphone.
- ㉔ **Front/Subwoofer Output RCA Connectors**
RED is down and WHITE is up.
- ㉕ **RCA Extension Cable (sold separately)**
- ㉖ **Front AUX Input Terminal**
This terminal allows for input of audio from an external device (such as a portable player), using a commercially-available converter cable.

- ㉗ **USB Terminal**
Connect this to a USB Memory or an iPod/iPhone (sold separately).

To prevent external noise from entering the audio system.

- Locate the unit and route the leads at least 10 cm away from the car harness.
- Keep the battery power leads as far away from other leads as possible.
- Connect the ground lead securely to a bare metal spot (remove any paint, dirt or grease if necessary) of the car chassis.
- If you add an optional noise suppressor, connect it as far away from the unit as possible. Your Alpine dealer carries various noise suppressors, contact them for further information.
- Your Alpine dealer knows best about noise prevention measures so consult your dealer for further information.

About the Rules of Bluetooth Electromagnetic Radiation Regulation



Declaration of Conformity

Declaration of Conformity

We, the undersigned,

Authorized representative in Europe : **Alpine Electronics (Europe) GmbH**

Address, City : **Wilhelm-Wagenfeld-Strasse 1-3, D-80807, Munich**

Country : **Germany**

certify and declare under our sole responsibility that the following apparatus :

Description : **CD Receiver**

Manufacturer : **Alpine Electronics, Inc.**

Brand : **ALPINE**

Identification : **CDE-133BT**

Installed Bluetooth module : **FC6000 (FC6000S)**

Test Report No. :

Radio : **MDE_PARRO_1101_RADa (7 layers AG)**

EMC : **MDE_PARRO_1101_EMCa (7 layers AG)**

LVD : **R051-26-11-101552/A Ed.0 (EMITECH ATLANTIQUE Lab.)**

conforms with the essential requirements of the Radio and Telecommunications Terminal Equipment Directive 1999/5/EC, based on the following specifications applied:

Radio : **EN300328 V1.7.1(2006-10)**
EMC : **EN301489-1 V1.8.1 (04/2008)**
LVD : **EN60950-1: 2006/A11: 2009)**

and therefore complies with the essential requirements and provisions of the R&TTE Directive.

The Technical documentation is kept at the following address:

Company : **Alpine Electronics (Europe) GmbH**

Address, City : **Wilhelm-Wagenfeld-Strasse 1-3, D-80807, Munich**

Country : **Germany**

Phone number : **49(0)89-324264-240**

Fax number/e-mail : **49(0)89-324264-241**

Name and position of person binding the manufacturer or his authorized representative : **Shinichi Asuke**
Global Engineering Strategy Office
Alpine Electronics, Inc.

Signature of the authorized person : *Shinichi Asuke*

Date of issue : **July 27, 2011**
