

FOR CAR USE ONLY



EN

6.5-INCH NAVIGATION / DVD RECEIVER
INE-W611D

- OWNER'S MANUAL
Please read before using this equipment.



ALPINE ELECTRONICS MARKETING, INC.

1-7, Yukigaya-Otsukamachi, Ota-ku,
Tokyo 145-0067, JAPAN
Phone: 03-5499-4531

ALPINE ELECTRONICS OF AMERICA, INC.

1500 Atlantic Boulevard, Auburn Hills,
Michigan 48326, USA
Phone 1-800-ALPINE-1 (1-800-257-4631)

ALPINE ELECTRONICS OF AUSTRALIA PTY. LTD.

161-165 Princes Highway, Hallam
Victoria 3803, Australia
Phone 03-8787-1200

ALPINE ELECTRONICS GmbH

Ohmstr. 4, 85716 Unterschleißheim,
Germany
Phone 089-32 42 640

ALPINE ELECTRONICS OF U.K. LTD.

Alpine House
Fletchamstead Highway, Coventry CV4 9TW, U.K.
www.alpine.co.uk

ALPINE ELECTRONICS GmbH

SUCCURSALE FRANCE
184 allée des Erables
CS 52016 – Villepinte
95 945 Roissy CDG cedex
FRANCE
Phone : +33(0)1 48 63 89 89

ALPINE ITALIA S.p.A.

Viale Cristoforo Colombo 8,
20090 Trezzano sul Naviglio MI, Italy
Phone +39 02 484781

ALPINE ELECTRONICS GmbH

SUCURSAL EN ESPAÑA
C/Portal de Gamarra 36, Pabellón 32
01007 Vitoria-Gasteiz
Phone 945-283588

PRECAUTIONS

IMPORTANT INFORMATION PLEASE READ CAREFULLY BEFORE USING THIS PRODUCT.	7
---	---

WARNING

Points to observe for safe usage	7
--	---

Copyrights and Trademarks

Copyrights and Trademarks.....	10
--------------------------------	----

Key Features

Key System Features.....	11
My Menu	11
Swiping the Touch Screen	11
About Dual Screen	11

Getting Started

Components and Features	12
Turning Power On/Off	12
Turning the System On	12
Resetting the System	13
Adjusting the Volume	13
Muting the Volume	13
Touch Screen Operation.....	13
Sound Settings	14
Voice Recognition	14
Switching Sources.....	14
Inputting Text (Keypad).....	15
Information Display on the Status Bar	15
Home Screen.....	16
Adding Your Favourite Menu Items to My Menu ..	16
Menu Screen	17

Radio/RDS

FM Radio Main Screen	18
MW/LW (AM) Radio Main Screen	18
Listening to FM/AM Radio.....	19
Selecting Radio Broadcasts.....	19
Saving Radio Broadcast to Presets.....	20
Using Preset Menu.....	20
RDS Operation	21
Traffic Announcement.....	21
Receiving Traffic Information Manually	21

Turning AF (Alternative Frequencies) On or Off	21
Regional Stations	21
Sound Settings	21

DAB

DAB Radio Main Screen.....	22
Listening DAB Radio	22
Selecting DAB Station.....	23
Saving DAB Station to Presets	23
Using Preset Menu.....	24
Traffic Announcement.....	24
Dynamic Range Control (DRC)	24
Setting the DAB Antenna ON/OFF	24
Service Following - Related (soft link)	
Contents On/Off.....	24
Sound Settings	24

Disc

Supported disc format	25
DVD Region Code.....	25

Disc Video

Disc Video Main Screen.....	26
Playing Disc Video Files.....	26
Viewing in Full Screen.....	26
Searching Disc Video Files	27
Fast-forwarding or Rewinding File	27
Repeat	27
Shuffle.....	27
Sound Settings	27
Visual Settings.....	27

Disc Music

Disc Music Main Screen.....	28
Playing Disc Music Files	28
Searching Disc Music Files	28
Fast-forwarding or Rewinding File	29
Repeat	29
Shuffle.....	29
Sound Settings	29

Data CD – Image Disc

Disc Image Main Screen.....	30
Playing Disc Image Files.....	30

Viewing in Full Screen.....	30
Searching Disc Image Files	30
Repeat	31
Shuffle.....	31
Visual Settings.....	31

Viewing File Info	41
Caption.....	41
Visual Settings.....	42
Sound Settings	42
Supported USB Video Format.....	42

Disc DVD

Disc DVD Main Screen	32
Playing a DVD.....	32
Viewing in Full Screen.....	32
Searching Chapters.....	33
Searching from Top Menu	33
Fast-forwarding or Rewinding Chapter.....	33
Repeat	33
Changing Screen Ratio.....	34
Using Top Menu.....	34
Using Sub Menu.....	34
Changing Subtitle Language	34
Changing Voice Language	34

Audio CD

Audio CD Main Screen.....	35
Playing Audio CD	35
Searching Tracks	35
Fast-forwarding or Rewinding Track.....	36
Repeat	36
Shuffle.....	36
Scan.....	36

USB Music

USB Music Main Screen	37
Playing USB Music Files	37
Searching USB Music Files	37
Fast-forwarding or Rewinding File	38
Repeat	38
Shuffle.....	38
Scan.....	38
Adding Song to Playlist	39
Deleting Playlist	39
Sound Settings	39
Supported USB Music Format	39

USB Video

USB Video Main Screen	40
Playing USB Video Files	40
Viewing in Full Screen.....	40
Searching USB Video Files.....	41
Fast-forwarding or Rewinding File	41
Repeat	41

USB Image

USB Image Main Screen	43
Playing USB Image Files	43
Viewing in Full Screen.....	43
Searching USB Image Files.....	43
Screen Settings	43

iPod Music

iPod Music Main Screen	44
Playing iPod Music.....	44
Searching iPod Music Files.....	45
Fast-forwarding or Rewinding File	45
Repeat	45
Shuffle.....	45
Sound Settings	45

Android Auto

What is Android Auto.....	46
Activate Android Auto.....	46

Apple CarPlay

Access to Apple CarPlay.....	46
------------------------------	----

HDMI

HDMI Main Screen.....	47
Playing HDMI Mode	47
Viewing in Full Screen.....	47
Changing Screen Ratio.....	47
Visual Settings	48
Sound Settings	48

AUX (Auxiliary Device)

AUX Main Screen.....	49
Playing AUX Mode	49
Viewing in Full Screen.....	49
Changing Screen Ratio.....	49
Visual Settings.....	49
Sound Settings	49

Bluetooth Audio

Bluetooth Audio Main Screen	50
Playing Bluetooth Audio	50
Connection Settings	51
When a Device is Already Paired	51
Fast-forwarding or Rewinding File	51
Repeat	51
Shuffle	51
Sound Settings	51

Bluetooth Operation

Setup Before Using	52
--------------------------	----

Phone

Pairing and Connecting a Phone	53
When no Phones Have Been Paired	53
When a Phone is Already Paired	53
When your phone is connected	53
Disconnecting Bluetooth Devices	54
Deleting Bluetooth Devices	54
Phone Screen	54
Bluetooth Phone Main Screen	54
Making a Call	55
Calling by Dialling a Number	55
Making a Call from Call History	55
Making a call from contacts	55
Making a Call from Favourites	56
Answering a Call	56
Operating Menus during a Call	57
Ending a Call	57
Switch Call to Private/Handsfree	57
Switching to Call Waiting	57
Turning Mic On/Off	58
Adjusting Call Volume	58
DTMF (Touch-Tone) Function	58
Contacts	58
Downloading Contacts	58
Searching Contacts	58
Information	59
Call History	59
Adjusting Call Volume	59
Information	59
Favourites	59
Saving to Favourites	59
Deleting Favourites	60
Bluetooth settings	60

Setup

Starting mode	61
---------------------	----

Bluetooth Settings	61
Bluetooth Connection	61
Setting Auto connection priority	63
Viewing Bluetooth System Info	64
Setting the Passkey	64
Resetting Bluetooth Settings	64
Sound Settings	65
Setting Tone/Fader/Balance	65
Setting Subwoofer	65
Setting MX HD	66
Setting EQ Presets	66
Setting the Crossover Settings (X-Over)	67
Setting the Time Correction	68
Setting Defeat	69
Setting Key Sound	69
Mute while backing up	70
Default Sound Settings	70
Visual Settings	70
Setting Brightness/Contrast/ Saturation/Hue	70
Screen Settings	71
Setting Screen/Lighting	71
Setting Screen Colour	71
Setting Illumination Colour	72
Setting Text Scroll	72
General Setup	72
Setting Screen Saver	72
Setting Language	73
Setting Security Code	73
Viewing System Info	73
Setting Demo Mode	74
Initializing the System	74
Car Settings	75
Setting Steering Wheel	75
Setting Installation Status	75
AUX Setup	75
Turning AUX On/Off	75
Setting AUX Name	76
Using Remote Control	76
Setting Signal	76
HDMI Settings	76
Camera Settings	77
Setting Camera Status	77
Setting Camera Signal	77
Setting Camera Guideline	77
Connectivity Settings	78
Setting Android Auto	78
Setting Apple CarPlay	79
Date/Time Settings	79
Receiving GPS Time	79
Converting Time Format	79
Turning Daylight Savings Time On/Off	79

Camera Operation

Rear Camera Operation.....	80
Displaying the Rear Camera Image from the Menu screen	80
Displaying the rear view video while the car is in reverse	80
Guideline Display ON/OFF	80
Hitch Guideline Display On/OFF	80
Switching the Front Camera image	80
About the Rear Camera Guideline	81

Information

Product Software Update.....	83
About the Supported Formats.....	83
About MP3/WMA/AAC/FLAC/ OGG/APE/MP2.....	83
In Case of Difficulty.....	85
Error Messages	86
Specifications	87

Operating Instructions

PRECAUTIONS

IMPORTANT INFORMATION PLEASE READ CAREFULLY BEFORE USING THIS PRODUCT.

- *This product is not a substitute for your personal judgement. Any route suggestions made by this navigation system should never supersede any local traffic regulations or your personal judgement and/or knowledge of safe driving practises. Do not follow route suggestions if the navigation system instructs you to perform an unsafe or illegal manoeuvre, places you in an unsafe situation, or routes you into an area which you consider unsafe.*
- *Glance at the screen only when necessary and safe to do so. If prolonged viewing of the screen is necessary, stop in a safe and legal manner and location.*
- *Do not input destinations, change settings, or access any functions requiring a prolonged view of the monitor while you are driving. Stop in a safe and legal manner and location before attempting to access the system.*
- *When using the navigation system to find/route to an emergency service, please contact the facility to validate and verify availability, prior to driving to it. Not all locations of emergency service providers such as police and fire stations, hospitals, and clinics are contained in the database. Please use your own judgement and your ability to ask for directions in these situations.*
- *The map database used in the navigation system is the most recent map data available at the time of production. Because of changes in streets and neighbourhoods, there may be situations where the navigation system may not be able to route you to your desired destination. In these cases, use your own personal judgement.*
- *The map database is designed to provide you with route suggestions, it does not take account of the relative safety of a suggested route, or of factors which may affect the time required to reach your destination. The system does not reflect road closures or construction, road characteristics (i.e. type of road surface, slope or grade, weight or height restrictions, etc.), traffic congestion, weather conditions, or any other factors which may affect the safety or timing of your driving experience. Use your personal judgement if the navigation system is unable to provide you with an alternate route.*
- *There may be situations where the navigation system may display the vehicle's location erroneously. Use your own driving judgement in this situation, taking into account current driving conditions. Please be aware that in this situation, the navigation system should correct the vehicle's position automatically; however, there may be times where you may have to correct the position yourself. If this is the case, stop in a safe and legal manner and location before attempting operation.*
- *Make certain that the volume level of the unit is set to a level which still allows you to hear outside traffic and emergency vehicles. Driving while unable to hear outside sounds could cause an accident.*
- *Please make certain that any other person who intends on using*

this navigation system reads these precautions and the following instructions carefully.

If there is anything in the manual about the operation of the navigation system which you are uncertain about, please contact your local Alpine authorised navigation dealer before using the navigation system.

WARNING

Points to observe for safe usage

- *Read this manual carefully before using this disc and the system components. They contain instructions on how to use this product in a safe and effective manner. Alpine cannot be responsible for problems resulting from failure to observe the instructions in this manual.*
- *This manual uses various pictorial displays to show you how to use this product safely and to alert you to potential dangers resulting from improper connections and operation. Following are the meanings of these pictorial displays. It is important to fully understand the meanings of these pictorial displays in order to use this manual and the system properly.*

WARNING

- *Operation of the system while driving is dangerous. Users should stop vehicle before operating the software.*
- *Road conditions and regulations take precedence over information contained on the map display; observe actual traffic restrictions and circumstances while driving.*
- *This software is designed for use exclusively in the unit. It cannot and may not be used in conjunction with other hardware.*



WARNING

This symbol means important instructions. Failure to heed them can result in serious injury or death.

INSTALL THE PRODUCT CORRECTLY SO THAT THE DRIVER CANNOT WATCH TV/VIDEO UNLESS THE VEHICLE IS STOPPED AND THE PARKING BRAKE IS APPLIED.

It is dangerous for the driver to watch TV/Video while driving a vehicle. Installing this product incorrectly enables the driver to watch TV/Video while driving. This may cause a distraction, preventing the driver from looking ahead, thus causing an accident. The driver or other people could be severely injured.

DO NOT WATCH VIDEO WHILE DRIVING.

Watching the video may distract the driver from looking ahead of the vehicle and cause an accident.

DO NOT OPERATE ANY FUNCTION THAT TAKES YOUR ATTENTION AWAY FROM SAFELY DRIVING YOUR VEHICLE.

Any function that requires your prolonged attention should only be performed after coming to a complete stop. Always stop the vehicle in a safe location before performing these functions. Failure to do so may result in an accident.

DO NOT FOLLOW ROUTE SUGGESTIONS IF THE NAVIGATION SYSTEM INSTRUCTS YOU TO PERFORM AN UNSAFE OR ILLEGAL MANEUVER, OR PLACES YOU IN AN UNSAFE SITUATION OR AREA.

This product is not a substitute for your personal judgement. Any route suggestions by this system should never supersede any local traffic regulations or your personal judgement or knowledge of safe driving practice.

KEEP THE VOLUME AT A LEVEL WHERE YOU CAN STILL HEAR OUTSIDE NOISES WHILE DRIVING.

Excessive volume levels that obscure sounds such as emergency vehicle sirens or road warning signals (train crossings, etc.) can be dangerous and may result in an accident. LISTENING AT LOUD VOLUME LEVELS IN A CAR MAY ALSO CAUSE HEARING DAMAGE.

MINIMIZE DISPLAY VIEWING WHILE DRIVING.

Viewing the display may distract the driver from looking ahead of the vehicle and cause an accident.

DO NOT DISASSEMBLE OR ALTER.

Doing so may result in an accident, fire or electric shock.

USE ONLY IN CARS WITH A 12 VOLT NEGATIVE GROUND.

(Check with your dealer if you are not sure.) Failure to do so may result in fire, etc.

KEEP SMALL OBJECTS SUCH AS SCREWS OUT OF THE REACH OF CHILDREN.

Swallowing them may result in serious injury. If swallowed, consult a physician immediately.

USE THE CORRECT AMPERE RATING WHEN REPLACING FUSES.

Failure to do so may result in fire or electric shock.

DO NOT BLOCK VENTS OR RADIATOR PANELS.

Doing so may cause heat to build up inside and may result in fire.

USE THIS PRODUCT FOR MOBILE 12V APPLICATIONS.

Use for other than its designed application may result in fire, electric shock or other injury.

MAKE THE CORRECT CONNECTIONS.

Failure to make the proper connections may result in fire or product damage.

BEFORE WIRING, DISCONNECT THE CABLE FROM THE NEGATIVE BATTERY TERMINAL.

Failure to do so may result in electric shock or injury due to electrical shorts.

DO NOT ALLOW CABLES TO BECOME ENTANGLED IN SURROUNDING OBJECTS.

Arrange wiring and cables in compliance with the manual to prevent obstructions when driving. Cables or wiring that obstruct or hang up on places such as the steering wheel, gear lever, brake pedals, etc. can be extremely hazardous.

DO NOT SPLICE INTO ELECTRICAL CABLES.

Never cut away cable insulation to supply power to other equipment. Doing so will exceed the current carrying capacity of the wire and result in fire or electric shock.

DO NOT DAMAGE PIPE OR WIRING WHEN DRILLING HOLES.

When drilling holes in the chassis for installation, take precautions so as not to contact, damage or obstruct pipes, fuel lines, tanks or electrical wiring. Failure to take such precautions may result in fire.

DO NOT USE BOLTS OR NUTS IN THE BRAKE OR STEERING SYSTEMS TO MAKE GROUND CONNECTIONS.

Bolts or nuts used for the brake or steering systems (or any other safety-related system), or tanks should NEVER be used for installations or ground connections. Using such parts could disable control of the vehicle and cause fire etc.

DO NOT INSTALL IN LOCATIONS WHICH MIGHT HINDER VEHICLE OPERATION, SUCH AS THE STEERING WHEEL OR GEARSHIFT.

Doing so may obstruct forward vision or hamper movement etc. and results in serious accident.

WARNING

This symbol means important instructions. Failure to heed them can result in injury or material property damage.

HALT USE IMMEDIATELY IF A PROBLEM APPEARS.

Failure to do so may cause personal injury or damage to the product. Return it to your authorized Alpine dealer or the nearest Alpine Service Center for repairing.

HAVE THE WIRING AND INSTALLATION DONE BY EXPERTS.

The wiring and installation of this unit requires special technical skill and experience. To ensure safety, always contact the dealer where you purchased this product to have the work done.

USE SPECIFIED ACCESSORY PARTS AND INSTALL THEM SECURELY.

Be sure to use only the specified accessory parts. Use of other than designated parts may damage this unit internally or may not securely install the unit in place. This may cause parts to become loose resulting in hazards or product failure.

ARRANGE THE WIRING SO IT IS NOT CRIMPED OR PINCHED BY A SHARP METAL EDGE.

Route the cables and wiring away from moving parts (like the seat rails) or sharp or pointed edges. This will prevent crimping and damage to the wiring. If wiring passes through a hole in metal, use a rubber grommet to prevent the wire's insulation from being cut by the metal edge of the hole.

DO NOT INSTALL IN LOCATIONS WITH HIGH MOISTURE OR DUST.

Avoid installing the unit in locations with high incidence of moisture or dust. Moisture or dust that penetrates into this unit may result in product failure.

NOTICE

Product Cleaning

Use a soft dry cloth for periodic cleaning of the product. For more severe stains, please dampen the cloth with water only. Anything else has the chance of dissolving the paint or damaging the plastic.

Temperature

Be sure the temperature inside the vehicle is between +45°C (+113°F) and 0°C (+32°F) before turning your unit on.

Maintenance

If you have problems, do not attempt to repair the unit yourself. Return it to your Alpine dealer or the nearest Alpine Service Station for servicing.

Protecting the USB connector

- Only compatible smartphones, iPods or USB Flash drives can be connected to the USB connector on this unit. Correct performance using other USB products cannot be guaranteed.
- If the USB connector is used, be sure to use only the supplied connector cable with the unit. A USB hub is not supported.
- Depending on the connected USB flash drive, the unit may not function or some functions may not be performed.
- The audio file format that can be played back on the unit is MP3/WMA/AAC/FLAC/OGG/APE/MP2.
- Artist/song name, etc., can be displayed. Certain, special characters may not be correctly displayed.

CAUTION

Alpine shall not be responsible for lost data even if such data is lost while using this product.

On Handling USB Flash drive

- This unit can control a memory storage device that supports the USB Mass Storage Class (MSC) protocol. Playable audio file formats are MP3, WMA, AAC, OGG, APE, MP2 and FLAC.
- USB Flash drive function is not guaranteed. Use USB flash drive according to the terms of agreement. Read the USB flash drive Owner's Manual thoroughly.
- Avoid usage or storage in the following locations:
 - Anywhere in the car exposed to direct sunlight or high temperatures.
 - Anywhere the possibility of high humidity or corrosive substances are present.
- Fix the USB flash drive in a location where driver operation will not be hindered.
- USB Flash drive may not function correctly at high or low temperature.
- Use only certified USB flash drive. Note that even certified USB flash drive, may not function correctly depending on its type or state.
- Depending on the settings of the USB flash drive type, memory state or encoding software, the unit may not play back or display properly.
- USB Flash drive may take time to start playback. If there is a particular file other than audio in the USB flash drive, it may take considerable time before the file is played back or searched.
- The unit can play back MP3, WMA, AAC, OGG, APE, MP2 or FLAC file extensions.
- Do not add the above extensions to a file other than audio data. This non-audio data will not be recognized. The resulting playback may contain noise that can damage speakers and/or amplifiers.
- It is recommended to back up important data on a personal computer.
- Do not remove the USB device while playback is in progress. Change SOURCE to something other than USB, then remove the USB device to prevent possible damage to its memory.

Copyrights and Trademarks

- Apple, iPhone, iPod, and iPod touch are trademarks of Apple Inc., registered in the U.S. and other countries. Apple CarPlay is a trademark of Apple Inc.
- Use of the Apple CarPlay logo means that a vehicle user interface meets Apple performance standards. Apple is not responsible for the operation of this vehicle or its compliance with safety and regulatory standards. Please note that the use of this product with iPhone, or iPod may affect wireless performance.
- "Made for iPod," and "Made for iPhone," mean that an electronic accessory has been designed to connect specifically to iPod, or iPhone, respectively, and has been certified by the developer to meet Apple performance standards. Apple is not responsible for the operation of this device or its compliance with safety and regulatory standards. Please note that the use of this accessory with iPod, or iPhone may affect wireless performance.
- Google, Android, Android Auto, Google Play and other marks are trademarks of Google Inc.
- Manufactured under license from Dolby Laboratories. Dolby and the double-D symbol are trademarks of Dolby Laboratories.
- The Bluetooth® word mark and logos are registered trademarks owned by the Bluetooth SIG, Inc. and any use of such marks by Alpine Electronics, Inc. is under license.
- The terms HDMI and HDMI High-Definition Multimedia Interface, and the HDMI Logo are trademarks or registered trademarks of HDMI Licensing, LLC in the United States and other countries.
- ©2006-2018 TomTom. All rights reserved. This material is proprietary and the subject of copyright protection, database right protection and other intellectual property rights owned by TomTom or its suppliers. The use of this material is subject to the terms of a license agreement. Any unauthorised copying or disclosure of this material will lead to criminal and civil liabilities.
-  is a trademark of DVD Format/Logo Licensing Corporation.

Key Features

Key System Features

My Menu

Frequently used functions such as the Audio or Navigation mode can be easily recalled by adding them to the My Menu screen. For details, see "My Menu Function" (page 16).

■ My Menu Screen Example



- Frequently used functions and useful functions can be customised for your convenience.
- You can register up to 8 menu items.
- You cannot add the same feature more than once.

Swiping the Touch Screen

You can change a screen or a page by swiping the touchscreen vertically or horizontally with your finger. For details, see "Touch Screen Operation" (page 13).

Swipe the display with your finger lightly.

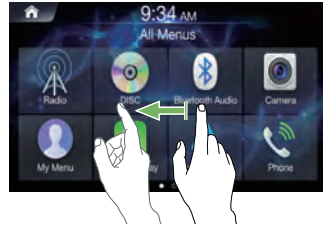

About Dual Screen

Dual Screen allows you to display the Navigation and Audio/Visual screens simultaneously.

Dual Screen



Touch Widget Screen



Navigation full Screen



Getting Started

Components and Features

INE-W611D

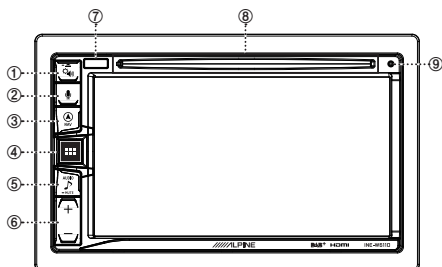

- ① **🔊 Sound Settings or Eject button**
Displays the [Tone/Fader/Balance] settings screen.
Press and hold this button to eject Disc.
- ② **📞 or VOICE button**
Depending on the connected smartphone, press to recall Siri function or voice recognition mode.
- ③ **📍 (NAV) button**
Recalls the navigation map screen.
Press again to switch to Navigation menu screen.
Press and hold this button for at least 2 seconds to change to Go Home route screen. (If Home is not set yet, it will change to the Home setting screen.)
For details of navigation operations, refer to "Navigation System OM (Owner's Manual)" in the CD-ROM.
Recalls the connected smartphone's map screen.
Depending on the smartphone, this function may not be available.
- ④ **☰ ALL MENUS or (Power Off) button**
Recalls the All Menus screen.
Press and hold this button for at least 2 seconds to turn the power off.
- ⑤ **🎵 (AUDIO) or -MUTE (MUTE) button**
Displays the Audio/Visual screen.
When pressed and held, mutes the volume.
- ⑥ **+ / - button**
Press to adjust the volume.
- ⑦ **Remote Sensor**
Point the remote control transmitter towards the remote sensor within a range of 2 metres.
- ⑧ **Disc insert slot**
Inserts/ejects discs
- ⑨ **RESET switch**
The system of this unit is reset.

About the button descriptions used in this Owner's Manual

The buttons found on the face of the unit are expressed in bold (e.g. MENU). The buttons found on the touch-screen display are shown in bold within brackets, [] (e.g. [x]).

Turning Power On/Off

Some of this unit's functions cannot be performed while the vehicle is in motion. Be sure to stop your vehicle in a safe location and apply the parking brake, before attempting these operations.

- 1 **Turn the ignition key to the ACC or ON position.**
The system turns on.
 - When turned on, the system displays the last screen that was displayed before the ignition key was turned off. For example, if the unit is in radio mode when ignition is turned off, it will remain in radio mode when ignition is turned back on.
- 2 **Press and hold the ALL MENUS/ (Power Off) button for more than 2 seconds to turn the power off.**
 - The unit can be turned on by pressing any button.

Turning the System On

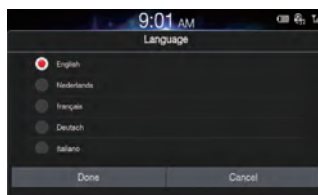

With the Alpine system, the home screen is displayed automatically when the ignition key is turned to ACC or ON.

When the system is used for the first time, the language selection menu is displayed. Swipe the Language list screen vertically, then touch your choice from the list of 9 languages.

- Some of this unit's functions cannot be performed while the vehicle is in motion. Be sure to stop your vehicle in a safe location and apply the parking brake before attempting these operations.

Resetting the System

Be sure to press the RESET switch when using the unit for the first time, after changing the car battery, etc.

- 1 Turn off the unit power.
- 2 Press the RESET switch with a ballpoint pen or similar pointed object.

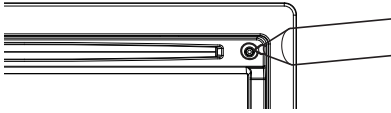

Adjusting the Volume

Adjust the volume by pressing the [+ , -] button. Volume decreases/ increases continuously by pressing and holding the [+ / -] button. Volume: 0 - 35

Muting the Volume

Audio Mute function instantly lowers the volume level to 0.

Press and hold the  button.

The Audio level will be 0.

Touch Screen Operation

You can operate the system by using the touch panel on the screen.

- Be sure to touch the onscreen button lightly with the pad of your finger to avoid scratching the display.

Touch operation

Touch a button or list item on the screen lightly.

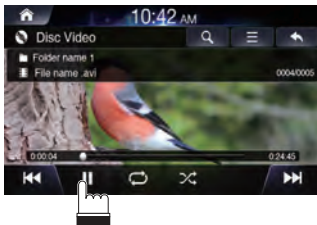

- If you touch a button and there is no reaction, remove your finger.
- Onscreen buttons that cannot be operated are dimmed.

Swipe operation

Move your finger lightly with a swipe.

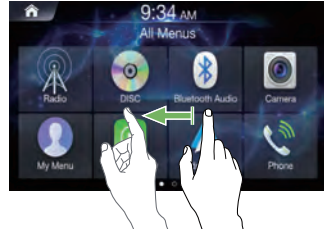

Drag & Drop operation

Touch and hold the desired item, then drag it to its new location by moving your finger, then release your finger to place the item.

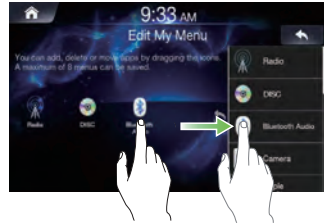

- It is not possible to narrow the screen with two fingers (pinch in) or spread the screen (pinch out).

Sound Settings

Press the  (Sound Setting) button to adjust sounds.

The [Tone/Fader/Balance] settings screen will be displayed.

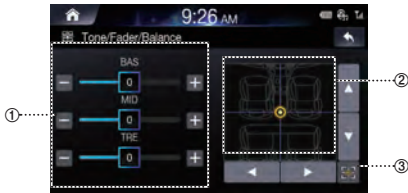

- ① Buttons for Tone Level
- ② Balance/Fader Area
- ③ Button for Centre Position

Use the ▲, ▼, ◀, ▶, 0, and  buttons to adjust settings.

Touch  to restore sound to the centre position.

Voice Recognition

You can use Siri function/Google voice function of your iPhone/Android phone.

- 1 Connect your phone and activate Apple CarPlay or Android Auto.
- 2 Press the  (Voice) button to start voice recognition.
- 3 Say the command.

Switching Sources

Press the  (AUDIO) button to change the source.

Switching sources using the  (AUDIO) button

During audio/visual playback, press the  (AUDIO) button repeatedly to switch to the desired source.

Radio → DAB → USB Music → USB Video → AUX → HDMI → Disc → Bluetooth Audio → Radio

*1 When no USB flash drive/iPod/Disc/Smartphone/Bluetooth compatible device is connected, this option is not available.

*2 The name set for "HDMI Name/AUX Name" is displayed.

*3 When AUX is set to "Off," this option is not available.

*4 Available when Apple CarPlay is used/Android smartphone which installed Android Auto App is connected.

To play Apple CarPlay music shall impact iPod source when an iPhone 5 or later is connected and vice versa. Refer to "Setting Apple CarPlay".

Switching Sources from the All Menu screen

1 Press the ALL MENUS button.

The menu screen is displayed.

- You can also display the menu screen by touching [All Menus] in home screen.

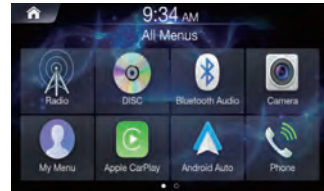

2 Touch your desired source in the Media source from all menus.

Inputting Text (Keypad)

The displayed screens and procedures may vary slightly depending on the function used, but the basic input method is the same.

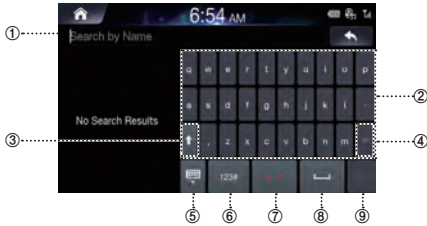

① Input area

② Characters

③ Shift

④ Delete

Returns to the previous character and erases it.
Touching and holding will erase quickly

⑤ Hides the keyboard

⑥ Current Keyboard Type

Touch to change keyboard type

⑦ Current Keyboard Type

Touch to change keyboard type

⑧ Space

⑨ Confirm

Information Display on the Status Bar

Displays the date and time along with the system status shown by the various icons to the right of the clock.

The icons in the following table indicate the various types of system status details and events.

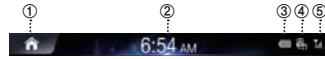

① Goes to the Home Screen.

② Clock

You can switch between the 12 hour display and 24 hour display options.

For details on clock display settings, refer to "Setting the Clock Display" (page 72).

③ Battery level of connected Bluetooth device.

Battery Level	No Battery	Level 1	Level 2	Level 3	Level 4	Level 5
Icon						

This feature may not be supported for some Bluetooth devices. The system will sound an alarm when the battery level decreases by one level.

④ Enabled when Bluetooth device is connected and connection is set to ON. Disabled when disconnected or connection is set to OFF.

: Bluetooth connection to audio device

: Bluetooth connection to Handsfree Phone Blinks while reconnecting.

⑤ Signal strength of connected Bluetooth device.

This feature becomes enabled when Bluetooth setting is ON.

	No Service	1	2	3	4	5	6
Icon							

Home Screen

Touch .

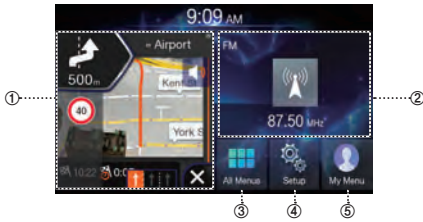

① Navigation Widget

Displays a brief view of the navigation map and the route screen.

Touch any area on the screen to move to the navigation screen.

② AV Widget

Displays brief information of radio or media currently playing.

Touch the area to move to the media screen currently playing.

③ All Menus

Shows all of the items in the system menu.

④ Setup

⑤ My Menu

Moves to the My Menu screen.

Add your favourite menus to have quick and easy access.

- The NAVI widget is displayed when a NAVI SD card is injected.

Adding Your Favourite Menu Items to My Menu

1 In the Home screen, touch [My Menu] → [Edit].

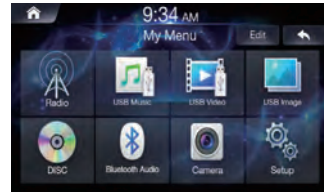

2 From the Edit My Menu screen, select menu items from the list on the right, then drag and drop them to the desired place on the left.

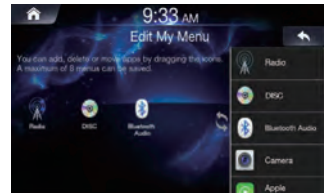

- Up to eight items can be added to My Menu.

Menu Screen

The Menu screen displays all of the available modes that can be selected to operate the system.

Press the All Menu button.
The menu screen is displayed.

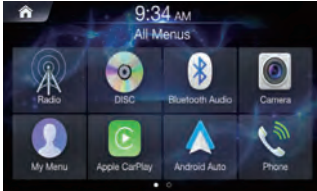

■ All Menu Screen example



- ① **Radio button**
Displays the Radio screen. (page 18)
- ② **DISC button**
Displays the DISC screen. (page 25)
- ③ **Bluetooth Audio button**
Displays the Bluetooth Audio screen. (page 50)
- ④ **Camera button**
Displays the Camera screen. (page 80)
- ⑤ **My Menu button**
Displays the My Menu screen. (page 11)
- ⑥ **Apple CarPlay**
Displays the Apple CarPlay screen. (page 46)
- ⑦ **Android Auto**
Displays the Android Auto screen. (page 46)
- ⑧ **Phone button**
Displays the Phone screen. (page 53)
- ⑨ **USB Music button**
Displays the USB Music screen. (page 37)
- ⑩ **USB Video button**
Displays the USB Video screen. (page 40)
- ⑪ **USB Image button**
Displays the USB Image screen. (page 43)
- ⑫ **iPod button**
Displays the iPod screen. (page 44)
- ⑬ **HDMI**
Displays the HDMI screen. (page 47)
- ⑭ **AUX button**
Displays the AUX screen. (page 48)
- ⑮ **Navigation button**
Displays the Navigation screen.
Refer to the Map Manual for more information.
- ⑯ **Setup button**
Displays the Setup screen. (page 61)

Radio/RDS

FM Radio Main Screen



① Radio Band Tab

If you select the desired tab, the selected Radio mode will operate.

② Menu (AF/Regional/Sound Settings)

③ Displays the Previous Screen

④ RDS Indicator (AF/EON/TP/TA/REG)

Displays the ON/OFF state of the features.

⑤ Information Display

Displays information such as frequency, station name, preset number, radio text.

⑥ Decreases Frequency

⑦ Displays the preset screen

⑧ Changes Tuning Mode

Switches the tuning mode used to search radio broadcasts between Manual, Preset, or DX Seek.

⑨ Displays the list screen

⑩ Traffic Announcement On/Off

⑪ Increases Frequency

- The RDS digital data includes the following: AF List of Alternative Frequencies EON Enhanced Other Networks TP Traffic Programme TA Traffic Announcement REG Regional

MW/LW (AM) Radio Main Screen

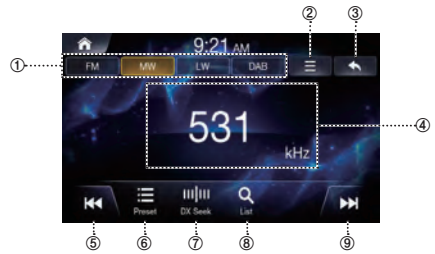

① Radio Band Tab

If you select the desired tab, the selected Radio mode will operate

② Menu (Sound Settings)

③ Displays the Previous Screen

④ Information Display

preset number and frequency

⑤ Decreases Frequency

⑥ Displays the preset screen





⑦ Changes Tuning Mode

Switches the tuning mode used to search radio broadcasts between Manual Tune, Preset, or DX Seek.

⑧ Displays the list screen

⑨ Increases Frequency

Listening to FM/AM Radio

- 1 Press the All Menus  button → touch [Radio].
Or in the Home screen, touch [All Menus] → [Radio].
- 2 Touch the desired band tab.
- 3 Touch  and select the desired tuning mode.
 - *DX Seek*: both strong and weak broadcasts will be tuned in.
 - *Manual*: the frequency is manually tuned in steps.
 - *Preset*: directly switches preset broadcasts.
- 4 Touch  or  and change the desired broadcast.

Selecting Radio Broadcasts

■ Selecting Broadcasts from Presets

- 1 Touch .



- 2 From the presets, select the frequency you want to listen to.

■ Selecting Broadcasts from List

- 1 Touch .

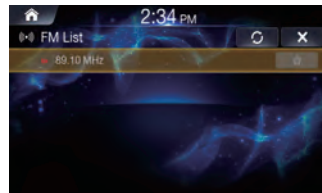

- 2 From the lists, select the frequency you want to listen to.

FM/AM lists are manually updated by pressing .

Saving Radio Broadcast to Presets

This feature is used to manually save the current broadcast to the desired preset number.

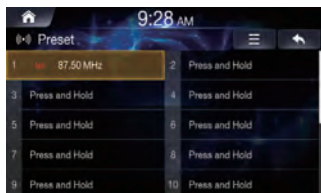

1 Tune the broadcast you wish to save.

2 Touch .



3 Touch and hold the [Press and Hold] area or the desired number area you want to save.

You can save a total of 20 stations or broadcasts as presets for each band (FM, MW, LW or DAB).

- In the List screen, you can also save the channel to preset by pressing .
- If a preset memory has already been set in the same preset number, it will be cleared and the new broadcast will be memorised.
- In the Presets screen, you can delete the saved presets. Touch  → [Delete all].

Using Preset Menu

1 Touch and hold the preset list you want to edit.

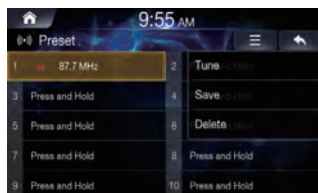

2 Select the desired option.

- *Tune*: plays the selected frequency.
- *Save*: overwrites frequency listening to currently.
- *Delete*: deletes frequency.

RDS Operation

Traffic Announcement

Touch .

The "TA" indicator is displayed and the unit switches to standby mode to receive traffic announcements.

When a traffic announcement is received, the "TP" indicator lights up and a corresponding popup is displayed. Press [Close] to close. Press [TA Off] to turn the TA feature off.

- The "TP" indicator lights up during standby mode off in a condition other than radio source to indicate that the unit is receiving the traffic announcement.
- If the traffic announcement broadcast signal falls below a certain level, the unit remains in the receiving mode for 1 minute.

Receiving Traffic Information Manually

1 Touch to turn on the Traffic Information mode.

The "TA" indicator lights up.

2 Touch .

Seeks the broadcast station which is broadcasting the traffic information.

- You can seek the traffic information in DX Seek mode.

Turning AF (Alternative Frequencies) On or Off

The RDS (Radio Data System) is a radio information system using the 57 kHz subcarrier of regular FM broadcasts. The RDS allows you to receive a variety of information such as traffic information, station names, and to automatically re-tune to a stronger transmitter that is broadcasting the same programme.

1 Touch .

2 Check the [AF] box to turn the feature on.

When AF is turned on, the "AF" indicator will be lit up.

- RDS mode is not displayed for the MW or LW band.
- When the AF is turned on, the unit automatically tunes to a strong signal broadcast in the AF list.
- Turn the AF off when automatic re-tuning is not required.

Regional Stations

This feature allows users to lock-down the device to their current region or allow the radio to tune into other region specific programming.

1 Touch .

2 Check the [Regional] box to turn the feature on.

When Regional feature is turned off, the unit automatically keeps receiving the local RDS station.

Sound Settings

Touch → [Sound Settings]

For details, refer to the "Sound" on the page 65.

DAB

DAB Radio Main Screen



① Radio Band Tab

If you select the desired tab, the selected Radio mode will operate.

② Menu (DRC, DAB Antenna , Soft link, Sound Settings)

③ Displays the Previous Screen

④ Slide Show

Displays the program information, artist photos, and advertisements that are synchronised with the Service component currently being received.

⑤ Information Display

Displays information such as frequency, station name, preset number, radio text.

⑥ DAB indicator (SL, TA, FM, DRC, DAB)

Displays the ON/OFF state of the features.

⑦ Decreases Frequency

⑧ Displays the preset screen

⑨ Changes Tuning Mode

Switches the tuning mode used to search radio stations between Service or Preset.

⑩ Displays the list screen

⑪ Traffic Information mode On/Off

⑫ Increases Frequency

Listening DAB Radio

1 Press the All Menus  button → touch [Radio]. Or in the Home screen, touch [All Menus] → [Radio].

2 Touch the DAB band tab.

3 Touch  and select the desired tuning mode.

- Service: switches the service components in the all service list.
- Preset: directly switches preset station.

4 Touch  or  and change the desired broadcast.

- Confirm the type of DAB antenna (sold separately) before using the DAB/DAB+/DMB function. If an active antenna that needs power supply from this unit is used, set DAB Antenna Power to On; if a passive antenna that does not need power supply from this unit is used, make sure to set DAB Antenna Power to Off, otherwise, a malfunction may occur.
- When FM Linking is tuned on, if the digital signal is weak, this unit will switch to receive the analogue FM radio signal automatically and the Link icon for Radio displays as FM Linking.
- This product only supports the "Receiver Profile 1 - Standard Audio Receiver" according to the official classification of WorldDMB Forum.

Selecting DAB Station

■ Selecting station from Presets

1 Touch .

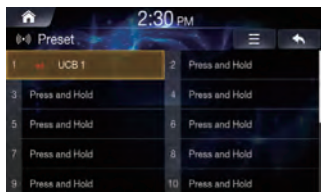

2 From the presets, select the station you want to listen to.

■ Selecting station from List

1 Touch .

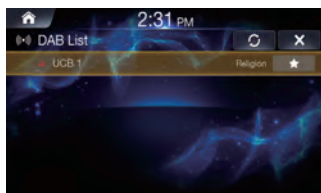

2 From the lists, select the station you want to listen to.

Press the Refresh  to update the list.

Saving DAB Station to Presets

This feature is used to manually save the current station to the desired preset number.

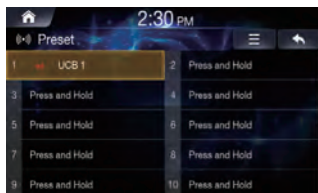

1 Tune the station you wish to save.

2 Touch .



3 Touch and hold the [Press and Hold] area or the desired number area you want to save.

You can save a total of 20 stations or broadcasts as presets for each band (FM, MW, LW or DAB).

- In the List screen, you can also save the channel to preset by pressing .
- If a preset memory has already been set in the same preset number, it will be cleared and the new station will be memorised.
- In the Presets screen, you can delete the saved presets. Touch  → [Delete all].

Using Preset Menu

1 Touch and hold the preset list you want to edit.

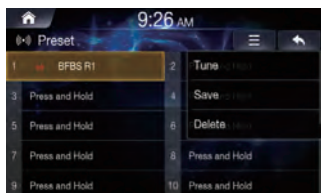

2 Select the desired option.

- *Tune*: plays the selected frequency.
- *Save*: overwrites frequency listening to currently.
- *Delete*: deletes frequency.

Traffic Announcement

Touch .

The "TA" indicator lights up and the unit switches to standby mode for the traffic announcement.

- Press the [TA OFF] button in the popup window to turn TA off. You can also press the  button at the bottom right side of the screen to toggle the TA feature ON/OFF.

Dynamic Range Control (DRC)

Dynamic Range Control (DRC) is a feature that maintains the radio volume at a consistent level for convenience and improved user experience.

1 Touch .

2 Check the [DRC] box to turn the feature on.

When DRC is turned on, the "DRC" indicator will be lit up.

Setting the DAB Antenna ON/OFF

You can choose whether to supply power to DAB Antenna Connector by this setting. Confirm the type of DAB Antenna (sold separately) before installing the DAB antenna. If an active antenna that needs power supply from this unit is used, set DAB Antenna Power to On; if a passive antenna that does not need power supply from this unit is used, make sure to set DAB Antenna Power to Off, otherwise, a malfunction may occur.

1 Touch .

2 Check the [DAB Antenna] box to turn the feature on.

- *Off (initial setting)*: When no DAB Antenna is connected or the connected DAB Antenna does not need power supply from this unit.
- *On*: When the connected DAB Antenna needs power supply from this unit.

- If the "DAB Antenna error." message is displayed on the unit, this setting becomes invalid. For details on what to do if "DAB Antenna error," is displayed, see "If this Message Appears".

Service Following - Related (soft link) Contents On/Off

This unit will automatically switch to an alternatively available service, if the reception quality of the current service is getting poor.

1 Touch .

2 Check the [Soft Link] box to turn the feature on.

- *Soft Link setting OFF [default setting]*:
The Service Following to only Hard Link services is active. Hard Link services do provide the same content than the originally tuned service.
- *Soft Link setting ON*:
The Service Following to both, Hard Link and Soft Link services is active.
Soft Link services do usually provide related content to the originally tuned service, however the content might also be different depending on broadcasters' configuration.

Sound Settings

Touch → [Sound Settings]

For details, refer to the "Sound" on page 65.

Disc

WARNING

- It is dangerous for the driver to watch the DVD/Disc, Video/Disc Image while driving the vehicle. The driver may be distracted from looking ahead and an accident could occur.
- Install the unit correctly so that the driver cannot watch DVD/Disc Video/Disc Image unless the vehicle is stopped, and the parking brake is applied.
- If the unit is not installed correctly, the driver will be able to watch DVD/Disc Video/Disc Image while driving the vehicle and may be distracted and could cause an accident. The driver or other people could be severely injured.



- Video/Image are not available while driving. (Because of traffic regulations, videos are only available when your vehicle is parked.)



Caution

- Not all functions will operate for every Disc. See the individual Disc's instructions for details on the features supported.
- Fingerprints on a disc may adversely affect playback. If a problem occurs, remove the disc and check for fingerprints on the playback side. Clean the disc if necessary.
- Turn on the car ignition before using this device. Do not operate this system for long periods of time with the ignition turned off as such operations may lead to battery discharge.
- Video CDs cannot be played.

Supported disc format

Supported Disc Formats	Disc Logo	Description
DVD Video		Displays discs with region codes of ALL or the corresponding region code.
Audio CD		Plays normal music CDs.
CD-R/RW		Plays discs recorded with music titles, WMA, and MP3 files.

DVD Region Code

The DVD Player and DVD discs are assigned region codes. DVDs without the proper region codes as supported by this device are not supported. Check the table below for more information on DVD region codes.

Region code	Area
1	United States, Canada
2	Europe, Middle East, South Africa
3	South Korea
4	Latin America
5	Russia, Africa
6	Mainland China
All	Can be played in all regions

Disc Video

You can play Music/Video/Image files stored in a disc on the internal player of this system.

WARNING

- It is dangerous (and illegal in many countries) for the driver to watch video while driving the vehicle. The driver may be distracted from looking ahead and an accident could occur.
 - Install the unit correctly so that the driver cannot watch video unless the vehicle is stopped, and the parking brake is applied.
 - If the unit is not installed correctly, the driver will be able to watch video while driving the vehicle and may be distracted from looking ahead and cause an accident. The driver or other people could be severely injured.
- Disc Video mode is not available while driving. (Because of traffic regulations, videos are only available when your vehicle is parked.)

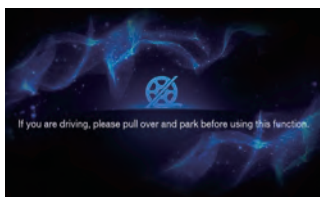



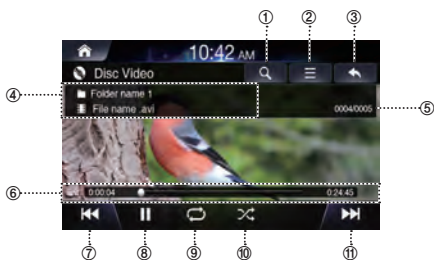

Disc Video Main Screen



- ① Displays the list screen
- ② Menu
- ③ Displays the Previous Screen
- ④ Information Display
- ⑤ Current File no. / Total File no.
- ⑥ Play Time and Play Bar
- ⑦ Previous File
- ⑧ Play/Pause
- ⑨ Repeat
- ⑩ Shuffle
- ⑪ Next File

Playing Disc Video Files

- 1 Press the All Menus  button → touch [DISC].
Or in the Home screen, touch [All Menus] → [DISC].
- 2 Touch  or  and select the desired file.
- 3 Touch  to play Disc video.
While playing, touch  to pause Disc video.

Viewing in Full Screen

Touch the screen in a non-menu area to change to full screen.
If you want to display the menu, touch the screen.

- If there are no operations for 10 seconds, the menu will automatically disappear.

Searching Disc Video Files

You can search the files in the List screen.



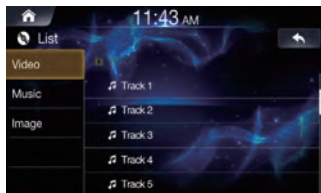

- 1 Touch  to display Disc File list screen.



- 2 Touch [Video] and search the desired file.
- 3 Touch the desired file to play.

Fast-forwarding or Rewinding File

Using  or .

- 1 While playing, touch and hold  or .
Touch and hold for more than 1 second to rewind or fast-forward at high speed.
- 2 Release  or  to play the file at normal speed.



Using Play Bar

Drag or touch the slider along the play bar to jump the point that you want to play from.

Repeat

Touch .
Each time the button is touched, the mode is changed.



Select the desired mode.

- Folder  : repeats the files in the current folder.
- One File  : repeats play of currently playing file.
- All  : repeats the all files in the Disc.

Shuffle

Touch .
Each time the button is touched, the mode is changed in order of On → Off.

Select the desired mode.

- Off  : turns the shuffle feature off.
- On  : plays all files in random order.

Sound Settings

Touch  → [Sound Settings]
For details, refer to the "Sound" on the page 65.

Visual Settings

Touch  → [Visual Settings]
For details, refer to the "Visual Settings" on the page 70.

Disc Music

You can play music files stored in a disc on the internal player of this system.

Disc Music Main Screen



- ① Displays the list screen
- ② Menu
- ③ Displays the Previous Screen
- ④ Disc Music Icon
- ⑤ Current Song no. / Total Song no.
- ⑥ Information Display
- ⑦ Play Time and Play Bar
- ⑧ Previous File
- ⑨ Play/Pause
- ⑩ Repeat
- ⑪ Shuffle
- ⑫ Scan
- ⑬ Next File

Playing Disc Music Files

- 1 Press the All Menus button → touch [DISC].
Or in the Home screen, touch [All Menus] → [DISC].
- 2 Touch to play Disc music.
While playing, touch to pause Disc music.

Searching Disc Music Files

You can search the files in the List screen.



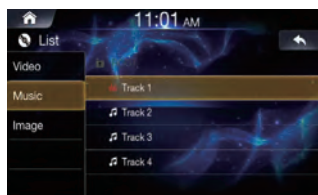

- 1 Touch to display Disc File list screen.



- 2 Touch [Music] and search the desired file.
- 3 Touch the desired file to play.

Fast-forwarding or Rewinding File

Using  or 

- 1** While playing, touch and hold  or .
Touch and hold for more than 1 second to rewind or fast-forward at high speed.
- 2** Release  or  to play the file at normal speed.

Using Play Bar



Drag or touch the slider along the play bar to jump the point that you want to play from.

Repeat

Touch .

Each time the button is touched, the mode is changed.

Select the desired mode.



- Folder  : repeats the files in the current folder.
- One File  : repeats play of currently playing file.
- All  : repeats the all files in the Disc.

Shuffle

Touch .

Each time the button is touched, the mode is changed in order of On → Off.

Select the desired mode.

- Off  : turns the shuffle feature off.
- On  : plays all files in random order.

Sound Settings

Touch  → [Sound Settings]

For details, refer to the "Sound" on the page 65.

Data CD – Image Disc





You can play Music/Video/Image files stored in a disc on the internal player of this system.

Disc Image Main Screen



- ① Displays the list screen
- ② Menu
- ③ Displays the Previous Screen
- ④ Information Display
- ⑤ Current Image no. / Total Image no.
- ⑥ Previous File
- ⑦ Play/Pause
- ⑧ Repeat
- ⑨ Shuffle
- ⑩ Next File

Playing Disc Image Files

- 1 Press the All Menus  button → touch [DISC].
Or in the Home screen, touch [All Menus] → [DISC].
- 2 Touch  or  and select the desired file.
- 3 Touch  to play Disc Image.
While playing, touch  to pause Disc image.

Viewing in Full Screen

Touch the screen in a non-menu area to change to full screen.
If you want to display the menu, touch the screen.

- If there are no operations for 10 seconds, the menu will automatically disappear.

Searching Disc Image Files

You can search the files in the List screen.

- 1 Touch  to display Disc File list screen.

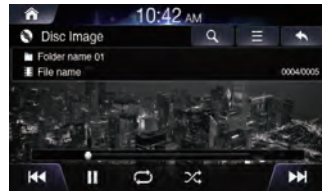



- 2 Touch [Image] and search the desired file.
- 3 Touch the desired file to play.

Repeat

Touch .

Each time the button is touched, the mode is changed.

Select the desired mode.



- Folder  : repeats the files in the current folder.
- One File  : repeats play of currently playing file.
- All  : repeats the all files in the Disc.

Shuffle

Touch .

Each time the button is touched, the mode is changed in order of On
→ Off.

Select the desired mode.

- Off  : turns the shuffle feature off.
- On  : plays all files in random order.

Visual Settings

Touch  → [Visual Settings].

For details, refer to the "Visual Settings" on the page 70.



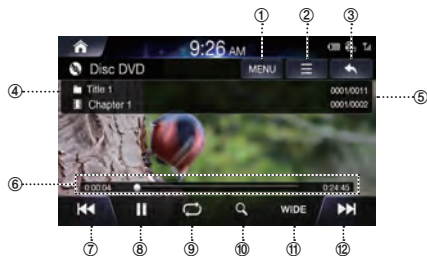

Disc DVD

Disc DVD Main Screen



- ① Displays the list screen
- ② Menu
- ③ Displays the Previous Screen
- ④ Chapter and Title Information
- ⑤ Chapter and Title Index
- ⑥ Play Time and Play Bar
- ⑦ Previous Chapter
- ⑧ Play/Pause
- ⑨ Repeat
- ⑩ Top menu
- ⑪ 16 : 9 / 4 : 3 LB / 4 : 4 PS
- ⑫ Next Chapter

Playing a DVD

- 1 Press the All Menus  button → touch [DISC].
Or in the Home screen, touch [All Menus] → [DISC].
- 2 Touch  or  or select the desired Chapter.
- 3 Touch  to play a DVD.
While playing, touch  to pause a DVD.

Viewing in Full Screen

Touch the screen in a non-menu area to view the DVD in full screen.

If you want to display the menu, touch the screen.

- If there are no operations for 10 seconds, the menu will automatically disappear.

Searching Chapters

1 Touch .

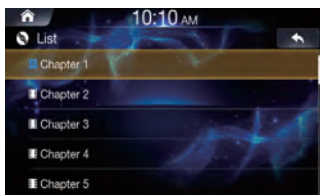

2 Search the desired chapter.

3 Touch the desired chapter to play.

Searching from Top Menu

1 Touch  to display Top Menu screen.

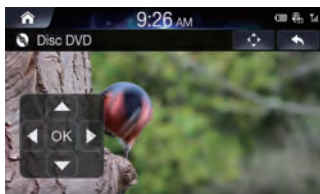



2 Touch .



3 Search the desired chapter and title.
Touch the controller up/down/left/right directions to select the desired menu and touch Enter .

- The Top menu and DVD menu options can only be used within DVDs that support these features.

Fast-forwarding or Rewinding Chapter

Using  or .

1 While playing, touch and hold  or .
Touch and hold for more than 1 second to rewind or fast-forward at high speed.

2 Release  or  to play the chapter at normal speed.

Using Play Bar



Drag or touch the slider along the play bar to jump the point that you want to play from.

Repeat

Touch .

Each time the button is touched, the mode is changed.

Select the desired mode.

- One Chapter  : repeats play of currently playing chapter.
- All  : repeats the all chapter in the current title.
- Disc  : repeats the all title in the DVD.

Changing Screen Ratio

- 1 Touch [Wide].
Each time the button is touched, the mode is changed.
- 2 Select the desired mode.
 - Wide: displays in 16:9 wide screen.
 - Normal: displays in 4:3 screen ratio.
 - Cinema: displays in 21:9 screen ratio

Using Top Menu

- 1 Touch [Top Menu] to display Top Menu screen.

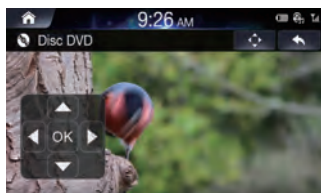

- 2 Touch the controller up/down/left/right directions to select the desired menu and touch Enter **OK**.
 - The Top menu and DVD menu options can only be used within DVDs that support these features.
 - Check [Menu Control] box to display the controller.

Using Sub Menu

- 1 Touch [Sub Menu] to display Sub Menu screen.

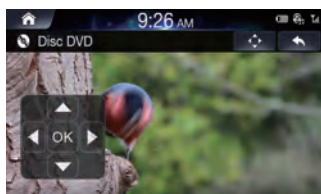

- 2 Touch the controller up/down/left/right directions to select the desired menu and touch Enter **OK**.
 - The Sub menu and DVD menu options can only be used within DVDs that support these features.
 - Check [Menu Control] box to display the controller.

Changing Subtitle Language

- 1 Touch  → [Subtitle].



- 2 Select the desired language.

- Supported caption languages may differ according to the DVD title.

Changing Voice Language

- 1 Touch  → [Audio].

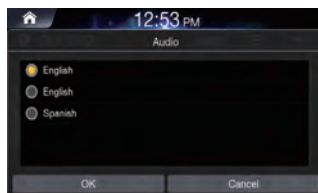

- 2 Select the desired language.

- Supported voice languages may differ according to the DVD title.

Audio CD

You can play music files stored in a disc on the internal player of this system.

Audio CD Main Screen

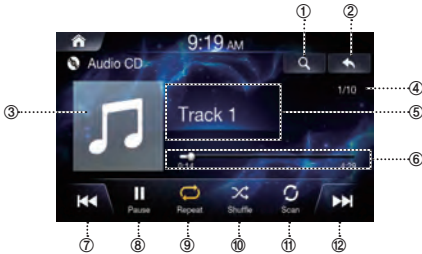

- ① Displays the list screen
- ② Displays the Previous Screen
- ③ Artwork Display
- ④ Current Song no. / Total Song no.
- ⑤ Information Display
- ⑥ Play Time and Play Bar
- ⑦ Previous Track
- ⑧ Play / Pause
- ⑨ Repeat
- ⑩ Shuffle
- ⑪ Scan
- ⑫ Next Track

Playing Audio CD

- 1 Press the All Menus button → touch [DISC]. Or in the Home screen, touch [All Menus] → [DISC].
- 2 Touch or or select the desired track.
- 3 Touch to play Audio CD. While playing, touch to pause Audio CD.

Searching Tracks

You can search the tracks in the List screen.



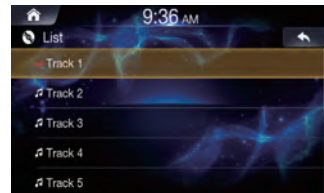

- 1 Touch to display Audio CD list screen.



- 2 Search the desired track.
- 3 Touch the desired track to play.

Fast-forwarding or Rewinding Track

Using  or .

- 1** While playing, touch and hold  or .
Touch and hold for more than 1 second to rewind or fast-forward at high speed.
- 2** Release  or  to play the track at normal speed.

Using Play Bar



Drag or touch the slider along the play bar to jump the point that you want to play from.

Repeat

Touch .

Each time the button is touched, the mode is changed.

Select the desired mode.



- One  : repeats play of currently playing track.
- All  : Repeats all of the tracks on the Audio CD.

Shuffle

Touch .

Each time the button is touched, the mode is changed.

Select the desired mode.

- On  : plays tracks in the Audio CD in random order.
- Off  : turns the shuffle feature off.

Scan

- 1** Touch .
The beginning part (approximately first 10 seconds) of all files within the current folder/category or the entire Audio CD are scanned.
- 2** Touch [Scan] to stop scanning.

USB Music

You can play back music files (MP3/WMA/AAC/FLAC/OGG/APE/MP2) stored on a USB flash drive.

USB Music Main Screen

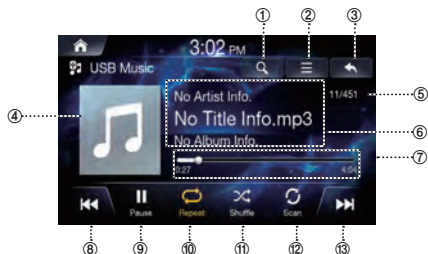

- ① Displays the list screen
- ② Menu (Album Cover, Add to Playlist, Sound Settings)
- ③ Displays the Previous Screen
- ④ Artwork Display
- ⑤ Current Song no. / Total Song no.
- ⑥ Information Display
- ⑦ Play Time and Play Bar
- ⑧ Previous File
- ⑨ Play / Pause
- ⑩ Repeat
- ⑪ Shuffle
- ⑫ Scan
- ⑬ Next File

Playing USB Music Files

- 1 Press the All Menus button → touch [USB Music]. Or in the Home screen, touch [All Menus] → [USB Music].
- 2 Touch or and select the desired file.
If play time is over 3 seconds, pressing will play the current file from the beginning.
- 3 Touch to play USB music.
While playing, touch to pause USB music.

Searching USB Music Files

You can search the music file in the List screen.

- 1 Touch to display USB Music list screen.

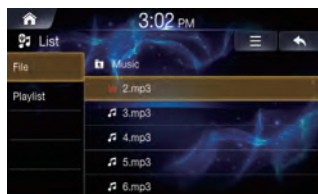

- 2 Search the desired category and file.
It is possible to search by File, Playlist, Artist, Song and Album.
 - 3 Touch the desired file to play.
- In the List screen, it is possible to add current song to playlist by touching → [Add to Playlist].

Fast-forwarding or Rewinding File

Using **⏮** or **⏭**.

- 1** While playing, touch and hold **⏮** or **⏭**.
Touch and hold for more than 1 second to rewind or fast-forward at 4x speed. Keep touching to switch the speed to 20x.
- 2** Release **⏮** or **⏭** to play the track at normal speed.

Using Play Bar





Drag or touch the slider along the play bar to jump the point that you want to play from.

Repeat

Touch .

Each time the button is touched, the mode is changed.

Select the desired mode.



- *Category*  : repeats the files in the current category.
- *Folder*  : repeats the files in the current folder.
- *One File*  : repeats play of currently playing file.
- *All*  : repeats the all files in the USB.

Shuffle

Touch .

Each time the button is touched, the mode is changed.

Select the desired mode.

- *On*  : plays files in the current category in random order.
- *Off*  : turns the shuffle feature off.

Scan

- 1** Touch .
The beginning part (approximately first 10 seconds) of all files within the current folder/category or the entire USB are scanned.
- 2** Touch **[Scan]** to stop scanning.

Adding Song to Playlist

- 1 While playing, touch  → [Add to Playlist].

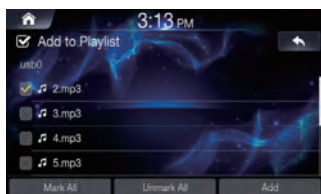

- 2 Select the desired songs and touch [Add].

Deleting Playlist

- 1 In the List screen, select Playlist category and touch  → [Delete].

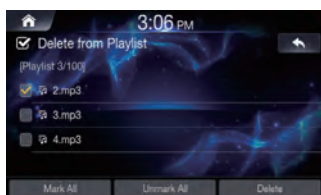

- 2 Select the desired playlist and touch [Delete].

Sound Settings

Touch  → [Sound Settings]
For details, refer to the "Sound" on the page 65.

Supported USB Music Format

Category	Description
MP3 File Specification	Response Specification: MPEG AUDIO LAYER3
Recommended Bitrate and Sampling Frequency	Response Sampling Frequency : 32, 44.1, 48 (KHz)
	Response Bitrate: 32, 40, 48, 56, 64, 80, 96, 112, 128, 160, 192, 224, 256, 320 (Kbps)
ID3 TAG	ID3 v1.1, ID3 v2.x TAG and ID3 v1.0
Detailed Specification	<ul style="list-style-type: none">• Max Directory Layers: 15 layers• Max length of folder names and file names: 255Bytes• Characters supported for folder/file names: English, Vietnamese and numbers• Max number of files recognized from one USB device(music + video + image): 5000

USB Video

You can play video files (AVI/MKV/MP4/ASF/WMV/MPG/3GP/MOV/FLV) stored in a USB flash drive on the internal player of this system.

WARNING

- It is dangerous (and illegal in many countries) for the driver to watch video while driving the vehicle. The driver may be distracted from looking ahead and an accident could occur.
 - Install the unit correctly so that the driver cannot watch video unless the vehicle is stopped, and the parking brake is applied.
 - If the unit is not installed correctly, the driver will be able to watch video while driving the vehicle and may be distracted from looking ahead and cause an accident. The driver or other people could be severely injured.
- USB Video is not available while driving. (Because of traffic regulations, videos are only available when your vehicle is parked.)









USB Video Main Screen



- ① Displays the list screen
- ② Menu (Caption, Sound Settings, Visual Settings)
- ③ Displays the Previous Screen
- ④ Information Display
- ⑤ Current Video no. / Total Video no.
- ⑥ Play Time and Play Bar
- ⑦ Previous File
- ⑧ Play / Pause
- ⑨ Repeat
- ⑩ Info
- ⑪ WIDE / NORMAL
- ⑫ Next File

Playing USB Video Files

- 1** Press the All Menus  button → touch [USB Video]. Or in the Home screen, touch [All Menus] → [USB Video].
- 2** Touch  or  and select the desired file.
 - If play time is over 3 seconds, pressing  will play the current file from the beginning.
- 3** Touch  to play USB video.
 - While playing, touch  to pause USB video.

Viewing in Full Screen

Touch the screen in a non-menu area to change to full screen. If you want to display the menu, touch the screen.

- If there are no operations for 10 seconds, the menu will automatically disappear.

Searching USB Video Files

You can search the files in the List screen.



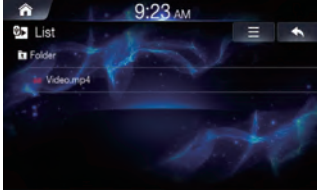

- 1 Touch  to display USB Video list screen.



- 2 Search the desired folder and file.
- 3 Touch the desired file to play.

Fast-forwarding or Rewinding File

Using  or .

- 1 While playing, touch and hold  or .
Touch and hold for more than 1 second to rewind or fast-forward at 4x speed. Keep touching to switch the speed to 20x.
- 2 Release  or  to play the file at normal speed.



Using Play Bar

Drag or touch the slider along the play bar to jump the point that you want to play from.

Repeat

Touch .
Each time the button is touched, the mode is changed.

Select the desired mode.

- Folder  : repeats the files in the current folder.
- One File  : repeats play of currently playing file.
- All  : repeats the all files in the USB.

Viewing File Info

Touch [Info].

The file information (File name, Resolution and Total Time) will be displayed.

Caption

- 1 Touch  → [Caption].

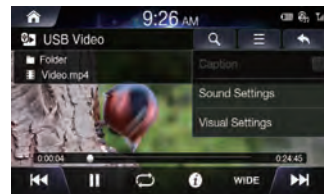

- 2 Check the caption box to display caption on USB Video screen.

Visual Settings

Touch  → [Visual Settings]

For details, refer to the “Visual Settings” on the page 70.

- *Operating the Visual Settings is not available while driving. (Because of traffic regulations, videos are only available when your vehicle is parked.)*

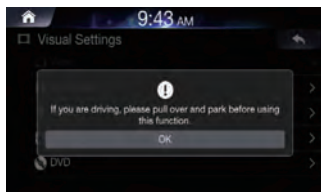

Sound Settings

Touch  → [Sound Settings]

For details, refer to the “Sound” on the page 65.

Supported USB Video Format

Category	Description
File Format	AVI, MPEG
Extensions	avi, mpg, mpeg, mp4, wmv
Video Codec	MPEG4-ASP, MPEG4-AVC(H.264), AVS, VP8
Video Resolution	1920 x 1080 (WMV 9: Max 8Mbps, 1280x720, WMV 8: 640x480)
Audio Codec	MP3, OGG, WMA ... (AC3 not supported)
Subtitles	SMI
Unsupported files	<ul style="list-style-type: none">• Files not compatible with supported specifications• Modified files (files with modified file formats)• Transformed files (example: AVI files encoded with WMV video codec)• Files without indexes

USB Image

You can play music/Video/Image files stored in a disc on the internal player of this system.

USB Image Main Screen



- ① Displays the list screen
- ② Screen Settings
- ③ Displays the Previous Screen
- ④ Information Display
- ⑤ Current Image no. / Total Image no.
- ⑥ Zoom in/out
- ⑦ Slide Show
- ⑧ Rotate Right
- ⑨ Info

Playing USB Image Files

- 1 Press the All Menus  button → touch [USB Image]. Or in the Home screen, touch [All Menus] → [USB Image].
- 2 Swipe left or right to display and select the desired file.

Viewing in Full Screen

Touch the screen in a non-menu area to change to full screen. If you want to display the menu, touch the screen.

- If there are no operations for 10 seconds, the menu will automatically disappear.

Searching USB Image Files

You can search the files in the List screen.

- 1 Touch  to display USB File list screen.



- 2 Search the desired file.
- 3 Touch the desired file to play.

- To change list type, touch  and select [List View] or Show Current Track.

Screen Settings

Touch  → [Screen Setting]
For details, refer to the "Screen Settings" on the page 71.

iPod Music

- The use of genuine iPod® cables supplied by Apple is recommended. (The use of other products may result in noise or abnormal operation.)
- Within iPhones, streaming audio and iPod® control may occasionally conflict. If problems persist, remove the iPhone and connect again.
- If iPod® and Bluetooth® are connected simultaneously with the same iPhone, you cannot use Bluetooth® audio function.
- Some iPods with unsupported communication protocols may not properly operate with the system.

Supported iPod Devices

- iPhone and iPod Touch devices are guaranteed to work normally on iOS 9.3.2 or below. However they may not work normally on future iOS versions as their operation have not yet been tested.





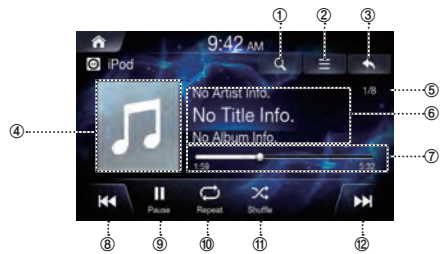

- iPod Classic
- iPod nano: 4-7th generation
- iPod touch: 2-5th generation
- iPod: 2-4th generation
- iPad Air: Air, Air2
- iPad mini: mini, mini 2, mini 3, mini retina
- iPhone: 3GS, 4, 4s, 5, 5s, 5c, 6, 6+

iPod Music Main Screen



- ① Displays the list screen
- ② Menu
- ③ Displays the Previous Screen
- ④ Artwork Display
- ⑤ Current Song no. / Total Song no.
- ⑥ Information Display
- ⑦ Play Time and Play Bar
- ⑧ Previous File
- ⑨ Play / Pause
- ⑩ Repeat
- ⑪ Shuffle
- ⑫ Next File

Playing iPod Music

- 1** Press the All Menus  button → touch [iPod Music]. Or in the Home screen, touch [All Menus] → [iPod Music].
- 2** Touch  or  and select the desired file. If play time is over 3 seconds, pressing  will play the current file from the beginning.
- 3** Touch  to play iPod music. While playing, touch  to pause iPod music.

The feature may operate differently depending on the iPod specification.

Searching iPod Music Files

You can search the files in the List screen.

- 1 Touch  to display iPod Music list screen.

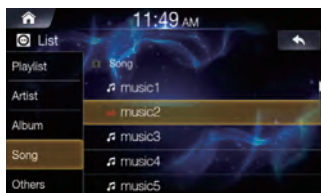



- 2 Search the desired category and file.
It is possible to search by Playlist, Artist Album, song and others.

- 3 Touch the desired file to play.

Fast-forwarding or Rewinding File

Using  or .

- 1 While playing, touch and hold  or .
- Touch and hold for more than 1 second to rewind or fast-forward at 4x speed. Keep touching to switch the speed to 20x.

- 2 Release  or  to play the file at normal speed.



Using Play Bar

Drag or touch the slider along the play bar to jump the point that you want to play from.

Repeat

Touch .
Each time the button is touched, the mode is changed.



Select the desired mode.

- One File  : repeats play of currently playing file.
- All  : repeats the all files in the USB.
- Off  : turns the repeat feature off.

Shuffle

Touch .
Each time the button is touched, the mode is changed.

Select the desired mode.

- On  : plays files within playlist in random order.
- Off  : turns the shuffle feature off.

Sound Settings

Touch  → [Sound Settings]
For details, refer to the "Sound" on the page 65.

Android Auto

What is Android Auto

Android Auto is designed to make it easier to use apps from your phone while you're on the road. Navigate with Google Maps, listen to playlists or podcasts from your favourite apps, and more.

Activate Android Auto

Download the Android Auto App from the Google Play store before continuing.

Just plug in your smartphone to the unit's USB connector, then follow the prompt to pair your smartphone with the unit.

- *The connected smartphone with Android Auto will disconnect other phone's Bluetooth connection and pair to the unit.*

1 Press the All Menus  button → touch [Android Auto]. Or in the Home screen, touch [All Menus] → [Android Auto].

2 The Android Auto screen is displayed.

- *When a used smartphone is reconnected, touch the pop-up message-"Android Auto connected" within 5 seconds to access to Android Auto screen, or you can ignore prompt by touching [X] on the top right.*
- *You can make a call, use voice recognition function and Android Auto's compatible navigation app, etc.,*
- *Only Google approved apps with necessary driver-safety measures in place can be used.*

Apple CarPlay

Apple CarPlay is a smarter, safer way to use your iPhone in the car. Apple CarPlay takes the things you want to do with your iPhone while driving and puts them right on the unit. You can get directions, make calls, send and receive messages, and listen to music, all in a way that allows you to stay focused on the road. Just plug in your iPhone to the unit and go.

- *Before using this function, turn Apple CarPlay to On and plug in your iPhone using Lightning to USB Cable (Supplied with iPhone) to the unit.*
- *Some functions may not be available while driving.*
- *About iPhone models usable with this unit, see "iPod/iPhone" (page 79). Only an iPhone 5 or later compatible with Apple CarPlay function.*

Access to Apple CarPlay

1 Press the All Menus  button → touch [Apple CarPlay]. Or in the Home screen, touch [All Menus] → [Apple CarPlay].

2 The Apple CarPlay mode is activated.

- *Touch the desired App icon on the unit, or use Siri function by pressing or  VOICE Key.*
- *When a used iPhone 5 or later is reconnected, touch the pop-up message-"Apple CarPlay connected." within 5 seconds to access to Apple CarPlay screen, or you can ignore prompt by touching [X] on the top right.*
- *The App must be Apple CarPlay compatible in order to appear in the Home screen.*

HDMI

Devices supporting HDMI can connect and play back through this unit. When making HDMI connections, you need to set HDMI on the unit suitable for the connected device.

- The HDMI/MHL connecting cable differs depending on the connected device corresponding to HDMI. Prepare optional HDMI/MHL connecting cable sets suitable for your device.
- The electronic device must possess an HDMI output interface.
- Not all devices with an HDMI output interface can be recognised by this unit.
- Use only the Alpine Special HDMI connection cable.

WARNING

- It is dangerous (and illegal in many countries) for the driver to watch video while driving the vehicle. The driver may be distracted from looking ahead and an accident could occur.
 - Install the unit correctly so that the driver cannot watch video unless the vehicle is stopped, and the parking brake is applied.
 - If the unit is not installed correctly, the driver will be able to watch video while driving the vehicle and may be distracted from looking ahead and cause an accident. The driver or other people could be severely injured.
- HDMI Video is not available while driving. (Because of traffic regulations, videos are only available when your vehicle is parked.)



HDMI Main Screen

HDMI Audio

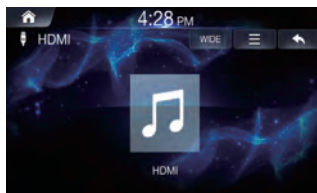

HDMI Video

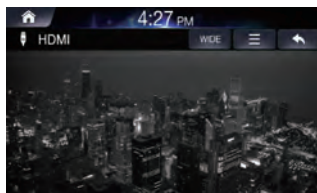

Playing HDMI Mode

- 1** Press the All Menus  button → touch [HDMI]. Or in the Home screen, touch [All Menus] → [HDMI].
- 2** Control directly within your HDMI device.

Viewing in Full Screen

Touch the screen in a non-menu area to change to full screen. If you want to display the menu, touch the screen.

- If there are no operations for 10 seconds, the menu will automatically disappear.

Changing Screen Ratio

- 1** Touch [Wide].
Each time the button is touched, the mode is changed.
- 2** Select the desired mode.
 - Wide: displays in 16:9 wide screen.
 - Normal: displays in 4:3 screen ratio.
 - Cinema: displays in 21:9 screen ratio

Visual Settings

Touch  → [Visual Settings]

For details, refer to the "Visual Settings" on the page 70.

- *Operating the Visual Settings is not available while driving. (Because of traffic regulations, videos are only available when your vehicle is parked.)*

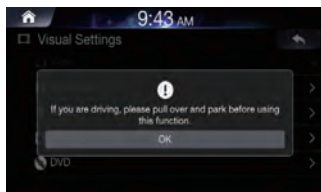

Sound Settings

Touch  → [Sound Settings]

For details, refer to the "Sound" on the page 65.

AUX (Auxiliary Device)

Devices supporting AUX can connect and play back through this unit. When making AUX connections, you need to set AUX on the unit suitable for the connected device.

- Set AUX to "On."
- Depending on the connected unit, the operation may differ.
- You can operate AUX, AUX DVD, GAME, Ext. DVD, DVD Changer, DVB-T, TV and -USB Player.

WARNING

- *It is dangerous (and illegal in many countries) for the driver to watch TV/video while driving the vehicle. The driver may be distracted from looking ahead and an accident could occur.*
 - *Install the unit correctly so that the driver cannot watch TV/video unless the vehicle is stopped and the parking brake is applied.*
 - *If the unit is not installed correctly, the driver will be able to TV/watch video while driving the vehicle and may be distracted from looking ahead and cause an accident. The driver or other people could be severely injured.*
- *AUX TV/Video is not available while driving. (Because of traffic regulations, videos are only available when your vehicle is parked.)*



AUX Main Screen

AUX Audio

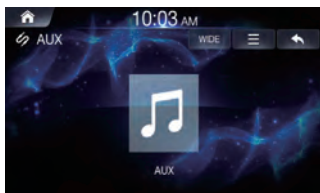

AUX Video

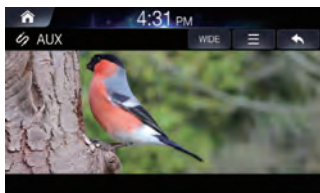

Playing AUX Mode

1 Press the All Menus  button → touch [AUX].
Or in the Home screen, touch [All Menus] → [AUX].

2 Control directly within your external device.

Viewing in Full Screen

Touch the screen in a non-menu area to change to full screen.
If you want to display the menu, touch the screen.

- If there are no operations for 10 seconds, the menu will automatically disappear.

Changing Screen Ratio

1 Touch [Wide].
Each time the button is touched, the mode is changed.

2 Select the desired mode.

- Wide: displays in 16:9 wide screen.
- Normal: displays in 4:3 screen ratio.
- Cinema: displays in 21:9 screen ratio

Visual Settings

Touch  → [Visual Settings]

For details, refer to the "Visual Settings" on the page 70.

- Operating the Visual Settings is not available while driving. (Because of traffic regulations, videos are only available when your vehicle is parked.)

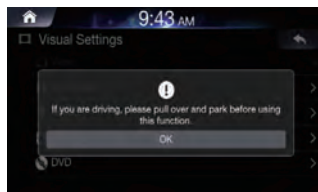

Sound Settings

Touch  → [Sound Settings]

For details, refer to the "Sound" on the page 65.

Bluetooth Audio

Music saved in the mobile phone, portable player, etc. can be played in the car through Bluetooth audio streaming.







- Bluetooth audio can be played only when a Bluetooth phone or Bluetooth audio device has been connected. To play Bluetooth audio, connect the Bluetooth phone to the car system. For more information on connecting Bluetooth, please refer to the user's manual [Pairing and connecting the unit and a Bluetooth phone] on page 61.
- The feature may operate differently depending on the Bluetooth device.

Bluetooth Audio Main Screen



- ① Menu
- ② Displays the Previous Screen
- ③ Bluetooth Icon
- ④ Information Display
- ⑤ Play Time and Play Bar
- ⑥ Previous File
- ⑦ Play/Pause
- ⑧ Repeat
- ⑨ Shuffle
- ⑩ Next File

Playing Bluetooth Audio

- 1 Press the All Menus  button → touch [Bluetooth Audio]. Or in the Home screen, touch [All Menus] → [Bluetooth Audio].**
 - 2 Touch  or  and select the desired file.**
If play time is over 3 seconds, pressing  will play the current file from the beginning.
 - 3 Touch  to play Bluetooth Audio.**
While playing, touch  to pause Bluetooth Audio.
- The title/artist info may not be supported in some devices. When it is not supported, only the symbol will be displayed.
 - The play/pause feature may operate differently depending on the device.

Connection Settings

Touch  → [Connections Settings] to set connections.

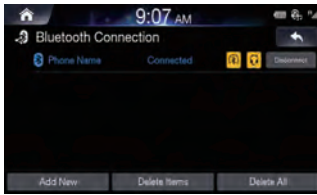

When a Device is Already Paired

■ Connecting a Bluetooth Device

1. Touch  → [Connections Settings].
2. Touch the device name to connect.

■ Disconnecting a Bluetooth Device

1. Touch  → [Connections Settings].
2. Touch the device name to disconnect.

■ Changing a Bluetooth Device





If multiple Bluetooth devices are registered in this system, you can change the connection from the registered devices.
If you want to connect a another device, first disconnect the connected Bluetooth device.

1. Touch  → [Connections Settings].
2. Disconnect the connected device.
3. Touch the device name to pair.

For details, refer to the "Bluetooth Connection" on the page 61.

Fast-forwarding or Rewinding File

Using  or .



- 1 While playing, touch and hold  or .
Touch and hold for more than 1 second to rewind or fast-forward at 4x speed. Keep touching to switch the speed to 20x.
- 2 Release  or  to play the track at normal speed.

Repeat

Touch .

Each time the button is touched, the mode is changed.

Select the desired mode.



- One File  : repeats play of currently playing file.
- On  : repeats all of the files in the Bluetooth Audio.
- Off  : turns the Repeat feature off.

Shuffle

Touch .

Each time the button is touched, the mode is changed.

Select the desired mode.

- On  : plays files in the current category in random order.
- Off  : turns the shuffle feature off.

Sound Settings

Touch  → [Sound Settings]

For details, refer to the "Sound" on the page 65.

Bluetooth Operation

Setup Before Using

■ About Bluetooth

Bluetooth is a wireless technology allowing communication between a mobile device or personal computer over short distances. This enables a handsfree call or data transmission between Bluetooth compatible devices. Bluetooth transmission is available in the unlicensed 2.4 GHz spectrum if the distance between devices is within 10 metres. For details, refer to the Bluetooth website (<http://www.bluetooth.com/>).

- *Depending on the Bluetooth version, a Bluetooth compatible device may not be able to communicate with this unit.*
- *Proper function of this unit with all Bluetooth compatible devices is not guaranteed. For handling of the Bluetooth compatible device, consult your Alpine dealer or Alpine website.*
- *Depending on the surroundings, Bluetooth wireless connection may be unstable.*
- *When you place a call, or perform setup operations, be sure to stop your car in a safe place.*
- *Depending on the connected Bluetooth compatible device(s), the function may differ. Also refer to the Owner's Manual of the connected device(s).*

■ About Handsfree Phone

Handsfree calls are possible when using a HFP (Hands-Free Profile) compatible mobile phone with this unit.

- *Avoid performing a handsfree call in heavy traffic or on narrow or winding streets.*
- *Close the windows while calling to reduce background noise.*
- *If both calling parties are using handsfree devices, or the call is made in a noisy location, difficulty hearing the other person's voice is normal.*
- *Depending on telephone line conditions or certain mobile devices used, voices may sound unnatural.*
- *When using a microphone, speak as directly as you can into the microphone to obtain the best sound quality.*
- *Certain mobile phone features are dependent on the capabilities and settings of your service provider's network. Additionally, certain features may not be activated by your service provider, and/or the provider's network settings may limit the feature's functionality.*
- *Always contact your service provider about feature availability and functionality.*
- *All features, functionality, and other product specifications, as well as the information contained in the Owner's Manual are based upon the latest available information and are believed to be accurate at the time of printing.*
- *Alpine reserves the right to change or modify any information or specifications without notice or obligation.*
- *Notice that when you connect an iPhone 5 or later/Android smartphone which installed Android Auto App, the operation screen may differ from this section.*

Phone

Pairing and Connecting a Phone

When no Phones Have Been Paired

- 1 Press the All Menus  button → touch [Phone]. Or in the Home screen, touch [All Menus] → [Phone].

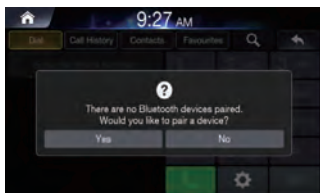

- 2 Touch [Yes].

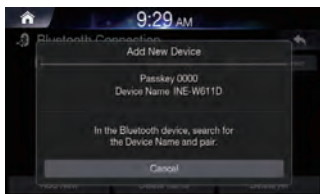

- 3 Pair from the Bluetooth Device
From the Bluetooth device, search for the car name and pair the device. When searching from the Bluetooth device, the car name is 'INE-W611D' and the default passkey is '0000'.

When a Phone is Already Paired

- 1 Press the All Menus  button → touch [Phone]. Or in the Home screen, touch [All Menus] → [Phone].

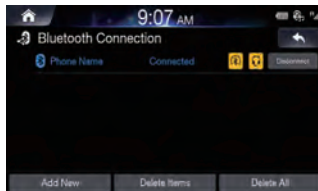

- 2 Select the device from the list and touch [Connect].

- When a Bluetooth device is connected, a new device cannot be paired. If you want to pair a new phone, first disconnect the connected Bluetooth device.

When your phone is connected

- 1 Press the All Menus  button → touch [Phone]. Or in the Home screen, touch [All Menus] → [Phone].

The following screen will be displayed.

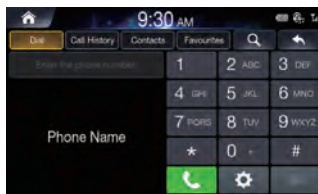

- Once Bluetooth connection is successful, the name of the connected mobile phone will be displayed on the phone screen and Bluetooth handsfree functions will be ready to be operated.
- Some functions may not be supported due to limited Bluetooth compatibility between the car system and mobile phone.

Disconnecting Bluetooth Devices

- 1 In the Phone screen, touch [Settings] → [Bluetooth Connection].

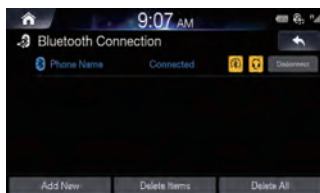

- 2 Select the currently connected device and touch [Disconnect].

Deleting Bluetooth Devices

- 1 In the Phone screen, touch [Settings] → [Bluetooth Connection].

- 2 Touch [Delete Item] and select the device you wish to delete.

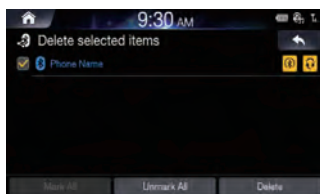

- 3 Touch [Delete].
To select all devices, press [Mark All].
To deselect all selected devices, press [Unmark All].

- A connected Bluetooth device cannot be deleted. First disconnect the connected Bluetooth device.
- If you want to delete all paired devices, touch [Delete all].
- Once a device is deleted, the call history and contacts that were saved to the head unit are also deleted.
- Touching [Cancel] will cancel the setting.

Phone Screen

Bluetooth Phone Main Screen





- 1 **Dial**
This is the main screen in which Bluetooth Phone operates.
- 2 **Call History**
Display the Call History screen.
- 3 **Contacts**
Display the Contacts screen.
- 4 **Favourites**
Display the Contacts screen. You can add frequently used numbers to Favourites to quickly find and call numbers.
- 5 **Search**
Displays the Contacts Search screen. You can search the contacts by name or phone number.
- 6 **Displays the Previous Screen**
- 7 **Number Field**
Shows entered numbers
- 8 **Search Results**
Displays the contact and number search results.
- 9 **Dial Pad**
Used to enter numbers. The entered numbers are shown in the number field.
- 10 **Call**
If a number has been entered, calls the number.
- 11 **Settings**
Displays the Bluetooth Settings Screen.
- 12 **Delete**
Deletes entered numbers.

Making a Call

Calling by Dialling a Number

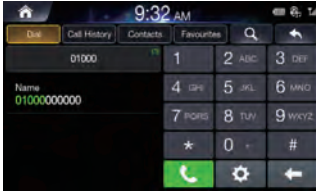
- 1 Enter number on the Dial Pad
- 2 Touch [Call].
The phone call is started.



- If you press the wrong number, press  to delete one digit of the entered number. Press and hold the dial pad 0 + to enter a "+".

■ Making a Call from Speed Dial

1. Enter the 1 or 2 digit speed dial number with the Dial Pad
2. Touch and hold the last number.
The phone call is started.

■ Calling through Redial

1. Touch and hold [Call].
The phone call is started.
- Redialling is not possible when there is no dialled calls list.

Making a Call from Call History

- 1 Touch [Call History]
- 2 Select the desired option.



- All: entire calls list
- Dialled Calls: dialled calls list
- Received Calls: received calls list
- Missed Calls: missed calls list

- 3 Select the contact you wish to call.
The phone call is started.

Making a call from contacts

- 1 Touch [Contacts]
- 2 Touch  → Select the desired search option.

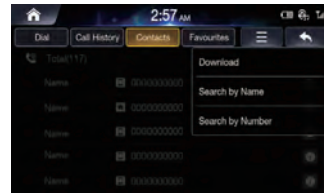

- 3 Enter the name or number.
- 4 Select the contact you wish to call.
The phone call is started.

Making a Call from Favourites

- 1 Touch [Favourites]
- 2 Select the contact you wish to call.
The phone call is started.

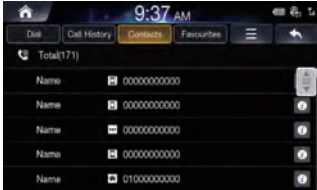

Answering a Call

- 1 When there is an incoming call you wish to accept, touch [Accept].
- 2 The incoming call is connected.

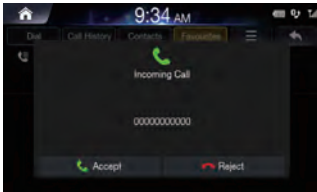

- During a call, the audio for the current mode on the unit is muted. After calling, playback will resume.
- When the caller's number is transmitted to the system, if the caller's name is stored in the phone book, the name is displayed. If the name is not stored, the number is displayed.
- Touch  (Reject) to reject an incoming call.

Operating Menus during a Call

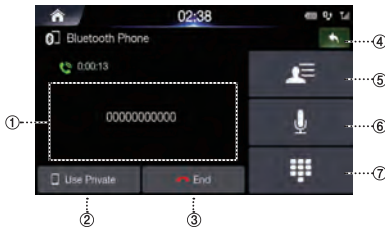

1 Info Display Window

2 Use Private

During a handsfree call, this function is used to switch the call to the mobile phone.

3 End

4 Displays the Previous Screen

5 Contacts

6 Mic Volume On/Off

7 Dial Pad

Ending a Call

1 Touch [End].

Switch Call to Private/Handsfree

1 During a handsfree call, press [Use Private] to switch the call to Bluetooth phone.

2 Once the call is switched to the cell phone, a message is displayed on the screen.

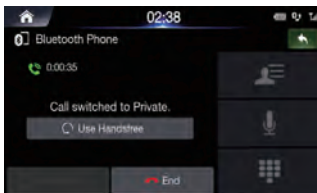

3 To switch the call back to the handsfree, press [Use Handsfree].

Switching to Call Waiting

If another person calls while you are already on a call, the current can be placed on hold or ended to answer the new call.

1 If there is a waiting call, the following screen will be displayed.



- *Hold 1st Call:* holds current call and answers new call.
- *End 1st Call:* ends current call and answers new call.
- *Reject:* rejects new call and maintains current call.

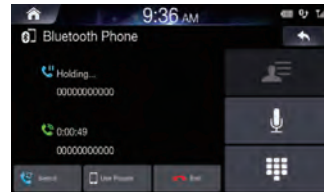

2 If there is a call waiting, touch [Switch] to switch to the waiting call.



- *To finish a call, touch [End].*

Turning Mic On/Off

This feature is used to mute the outgoing volume to the other party.

- 1 During a call, touch .
- 2 To Turn the mic back on, touch  again.

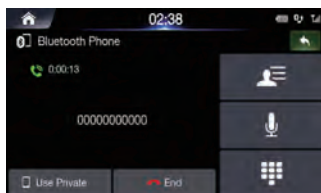

Adjusting Call Volume

This menu is used to adjust the mic volume during calls.

Press the volume (+/-) button to adjust the mic volume.

DTMF (Touch-Tone) Function

This menu is used to display keypad during calls.

- 1 Touch .
The number input screen (Keypad) displays.
- 2 Enter number.

Contacts

Downloading Contacts

Up to 5,000 mobile phone contacts can be updated.

- 1 Touch  → [Download].

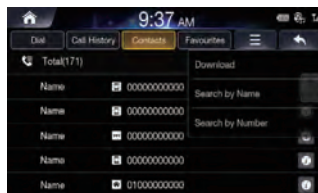

- 2 The contacts are deleted and the contacts of the connected phone is updated.

Searching Contacts

- 1 Touch  → [Search by Name] or [Search by Number].

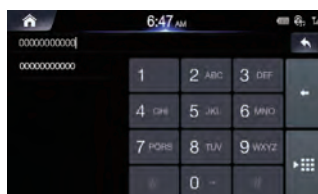
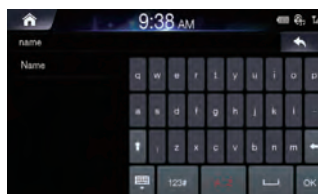

- 2 Enter the name or number.
- 3 Select the contact you wish to call.
The phone call is started.

- For details of how to input characters using the keypad, see "How to Input Characters and Numbers (Keypad)" (page 15).
- You can also search contact by touching  in the Bluetooth Phone main screen.

Information

1 Touch .

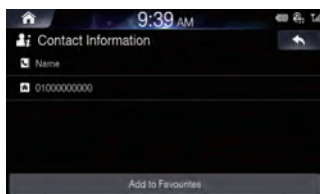

2 Touch [Add to Favourites] to add contact to Favourites.

Call History

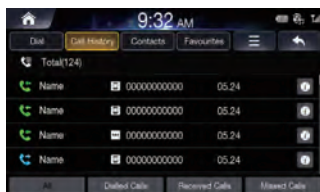

- All: entire calls list
- Dialed Calls: dialed calls list
- Received Calls: received calls list
- Missed Calls: missed calls list

Information

1 Touch .

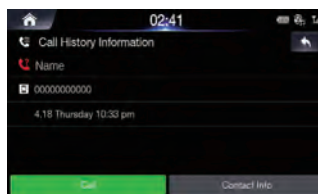

2 Touch [Call] to make a call

3 Touch [Contact info] → [Add to Favourites] to add contact to Favourites.

Favourites

You can add frequently used numbers to Favorites to quickly find and call numbers.

Saving to Favourites

1 When no Favourites have been added, the following screen will be displayed.

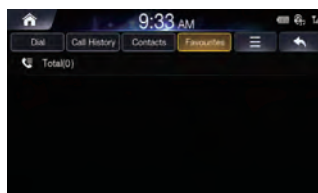

2 Touch [Add New].

3 Select the contact you wish to add from the contacts.

- When a Favourites is already added, touch  → [Add New].

Deleting Favourites

1 Touch  → [Delete Item].

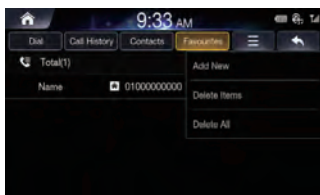

2 Select the contacts and touch [Delete].

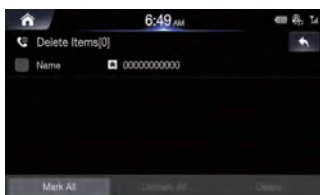

- If you want to delete all, touch  → [Delete all].

Bluetooth settings

1 Touch [Settings].

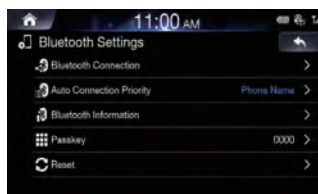

For details, refer to the "Bluetooth Settings" on the page 61.

Setup

Starting mode

- 1 Press the All Menus  button → touch [Setup].
Or in the Home screen, touch → [Setup].

The Setup main screen will be displayed.

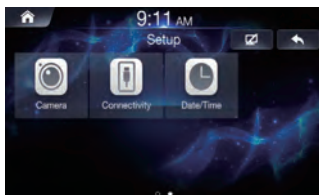
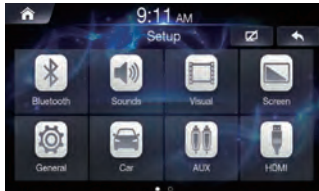

- 2 Touch the required setting icon on the upper part of the Setup main screen or swipe the list to the left/right. Then touch the setting item.

Bluetooth Settings

This menu allows you to set Bluetooth® settings.

- 1 In the Setup screen, touch [Bluetooth].

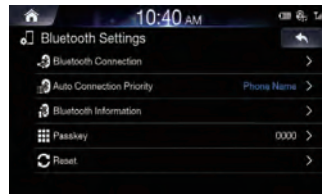

Bluetooth Connection

This menu allows you to manage the Bluetooth device list, such as pairing, connecting or deleting Bluetooth devices.

- 1 In the Bluetooth Settings screen, touch [Bluetooth Connection].

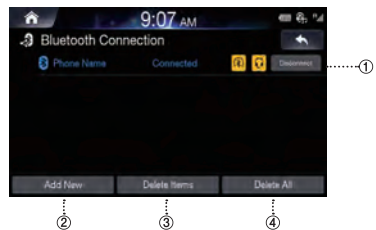

- ① **Connect/Disconnect**
connects/disconnects a Bluetooth device.
- ② **Add new**
pairs a new Bluetooth device.
- ③ **Delete item**
deletes a paired Bluetooth device.
- ④ **Delete all**
deletes all paired Bluetooth devices.

■ Pairing and Connecting a Phone - When no Phones Have Been Paired

1. Touch [Add New].

Or in the Home screen, touch [All Menus] → [Phone].

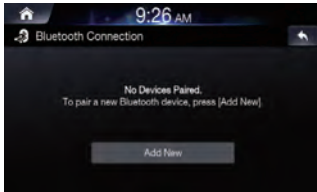

2. Pair from the Bluetooth Device.

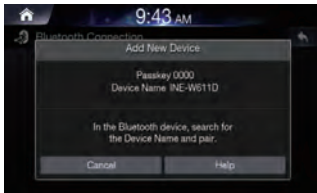

From the Bluetooth device, search for the AVN unit name and pair the device. When searching from the Bluetooth device, the AVN unit name is 'INE-W611D' and the default passkey is '0000'.

• Some Bluetooth devices may require you to enter the passkey while others may not.

3. Once Bluetooth connection is successful, the name of the connected Bluetooth device will be displayed on the screen.

■ When a Phone is Already Paired

Select the device from the list and touch [Connect].

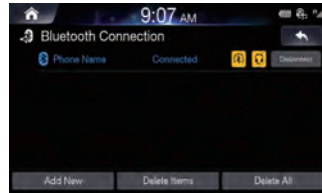

• When a Bluetooth device is connected, a new device cannot be paired. If you want to pair a new phone, first disconnect the connected Bluetooth device.

• You can register up to 5 Bluetooth compatible mobile phones.

• If all 5 devices have been registered, you cannot register a 6th device. To register another device, you need to delete one of the other 5 devices first.

■ Disconnecting Bluetooth Devices

Select the currently connected device and touch [Disconnect].

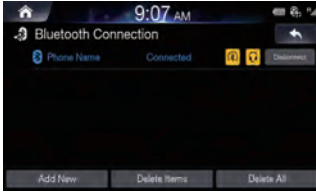

■ Deleting Bluetooth Devices

1. Touch [Delete Item] and select the device you wish to delete.

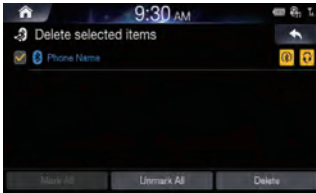

2. Touch [Delete].

To select all devices, press [Mark All].

To deselect all selected devices, press [Unmark All].

- A connected Bluetooth device can be deleted by pressing *Yes* in the popup window alerting you that the device will first be disconnected.
- If you want to delete all paired devices, touch [Delete all].
- Once a device is deleted, the call history and contacts that were saved to the head unit are also deleted.
- Touching [Cancel] will cancel the setting.

Setting Auto connection priority

The Bluetooth device will automatically be connected according to the option set when the car ignition is turned on.

1 In the Bluetooth Settings screen, touch [Auto connection priority].

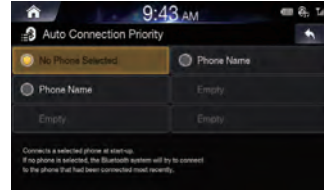

2 Select the Bluetooth device you wish to set priority connection.

If you touch [No Phone Selected] button, the most recently connected Bluetooth® phone will connect automatically.

Viewing Bluetooth System Info

This feature is used to change the Bluetooth vehicle name and system information.

- 1 In the Bluetooth Settings screen, touch [Bluetooth Information].



Setting the Passkey

This feature allows you to change the passkey used for Bluetooth device authentication.

- 1 In the Bluetooth Settings screen, touch [Passkey].

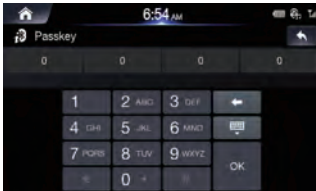

- 2 Enter the passkey and touch [OK]
The phone call is started.

- The default passkey is 0000.

Resetting Bluetooth Settings

This feature is used to restore all Bluetooth settings back to default state.

- 1 In the Bluetooth Settings screen, touch [Reset].

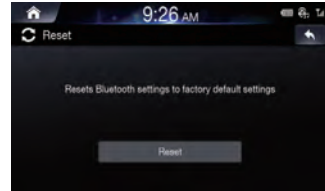

- 2 Touch [Reset] → [Yes].

Sound Settings

This menu is used to adjust the sound effects for the whole system.

1 In the Setup screen, touch [Sounds].

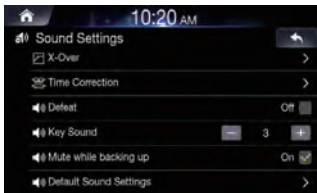
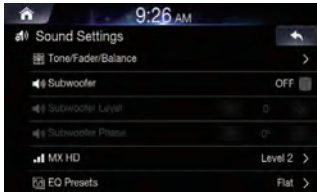

Setting Subwoofer

1 Check the [Off] box to turn subwoofer feature on.

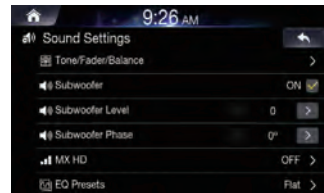

2 Adjust the subwoofer level and phase using [$<$, $>$].

- The Subwoofer Level and Phase features are unavailable when the Subwoofer feature is turned off.
- The subwoofer level can be set from 0 to 15.
- The subwoofer output phase is toggled Subwoofer Normal (0°) or Subwoofer Reverse (180°).

Setting Tone/Fader/Balance

1 In the Sounds Settings screen, touch [Tone/Fader/Balance].

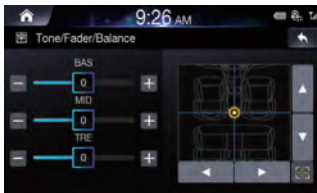

2 Use the \blacktriangle , \blacktriangledown , \blacktriangleleft , \blacktriangleright , 0, and  buttons to adjust settings.

Touch  to restore sound to the centre position.

Setting MX HD

Media Xpander (MX HD) makes vocals or instruments sound distinct regardless of the music source. The Radio FM/DAB, USB Flash drive and iPod/iPhone, will be able to reproduce the music clearly even in cars with a lot of road noise.

1 In the Sounds Settings screen, touch [MX HD].

2 Set the desired option.

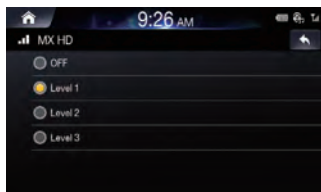

Media: Off/Level1/Level2/Level3: The medium to high frequencies become more clear, and produces well balanced sound in all the bands.

When AUX is connected, the options will be [Off, Compressed Media / Movie / Music].

AUX: Off / Compressed Media / Movie / Music : Choose the MX HD mode (Compressed Media, Movie, or Music) that corresponds to the media connected.

- When the Defeat setting is "On," you cannot perform the set up.
- The MX HD setting can be performed only when a source is currently selected.
- The effectiveness increases as the MX HD setting value increases Level1 Level2 Level3.
- Movie: The dialogue portion of the video is reproduced more clearly
- Music: This disc contains a large quantity of data such as music clip. MX uses this data to reproduce the sound accurately.

Setting EQ Presets

10 typical equalizer settings are preset at the factory for a variety of musical source material.

1 In the Setup screen, touch [EQ Presets].



- Only one type can be set to ON.
- The Equalizer Presets setting can be configured when Defeat is "Off."

Setting the Crossover Settings (X-Over)

■ About the Crossover

This unit is equipped with an active crossover. The crossover limits the frequencies delivered to the outputs. Each channel is controlled independently. Thus, each speaker pair can be driven by the frequencies for which they have been optimally designed.

The crossover adjusts the HPF (high pass filter) or LPF (low pass filter) of each band, and also the slope (how fast the filter rolls off the highs or lows).

Adjustments should be made according to the reproduction characteristics of the speakers. Depending on the speakers, a passive network may not be necessary. If you are unsure about this point, please consult your authorized Alpine dealer.

	Cut-off frequency (1/3 octave steps)		Slope		Level
	HPF	LPF	HPF	LPF	
Subwoofer (LPF)	----	20 Hz - 200 Hz	----	0, 6, 12, 18, 24 dB/oct.	0 to -12 dB
Rear speaker (HPF)	20 Hz - 200 Hz	----	0, 6, 12, 18, 24 dB/oct.	----	0 to -12 dB
Front speaker (HPF)	20 Hz - 200 Hz	----	0, 6, 12, 18, 24 dB/oct.	----	0 to -12 dB

Low range

High range

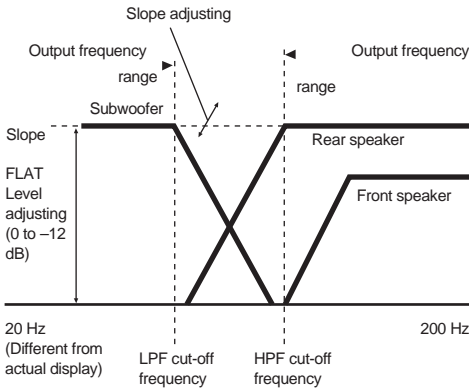

- **HPF (high pass filter):** Cuts the lower frequencies and allows the higher frequencies to pass.
- **LPF (low pass filter):** Cuts the higher frequencies and allows the lower frequencies to pass.
- **Slope:** The level change (in dB) for a frequency change of one octave.
- The higher the slope value, the steeper the slope becomes.
- Adjust the slope to FLAT to bypass the HP or LP filters.
- Do not use a tweeter without the HPF on or set to a low frequency, as it may cause damage to the speaker due to the low frequency content.

- Adjustment should be made according to the recommended crossover frequency of the connected speakers. Determine the recommended crossover frequency of the speakers. Adjusting to a frequency range outside that recommended may cause damage to the speakers.

For the recommended crossover frequencies of Alpine speakers, refer to the respective Owner's Manual. We are not responsible for damage or malfunction of speakers caused by using the crossover outside the recommended value.

1. In the Setup screen, touch [X-Over].

2. Touch [Channel] to select the channel.

Each time you touch, the channel switches.



- The channel being adjusted is displayed in red.

Front HPF → Rear HPF → Subw. LPF → Front HPF

3. Adjust the crossover to your preference.

Selecting the Cut-Off Frequency

Touch or of "Frequency," and then select the cut-off frequency. (20 / 25 / 31.5 / 40 / 50 / 63 / 80 (Initial setting) / 100 / 125 / 160 / 200)

Adjusting the Slope

Touch or of "Slope," and then adjust the HPF or LPF slope. (0 (Initial setting) / 6 / 12 / 18 / 24 dB/oct.)

Adjusting the Level

Touch or of "Level," and then adjust the HPF or LPF level. (-12 to 0 dB (Initial setting: 0))

4. Repeat steps 1 to 2 to make adjustment to the other channels.

5. To store the adjusted setting value, touch and hold [Preset 1], [Preset 2], or [Preset 3] for at least 2 seconds.

- Touch [Flat] to initialise all values.
- If the Subwoofer setting is "Off," the Subwoofer setting cannot be edited.
- While adjusting the X-OVER you should consider the frequency response of the connected speakers.

Calling the X-OVER adjusted value

Calling the pre-set X-OVER adjusted value.

Touch [Preset 1], [Preset 2], or [Preset 3] on the X-OVER screen.

The setting stored in the Preset will be recalled.

Setting the Time Correction

■ About Time Correction

The distance between the listener and the speakers in a car vary widely due to the complex speaker placement. This difference in the distances from the speakers to the listener creates a shift in the sounds image and frequency characteristics. This is caused by the time delay between the sound reaching the listener's right versus the left ear.

To correct this, this unit is able to delay the audio signal to the speakers closest to the listener. This effectively creates a perception of increased distance for those speakers. The listener can be placed at an equal distance between the left and right speakers for optimum staging. The adjustment will be made for each speaker in 3.4 cm steps.

Example 1. Listening Position: Front Left Seat

Adjust the time correction level of the front left speaker to a high value and the rear right to zero or a low value.

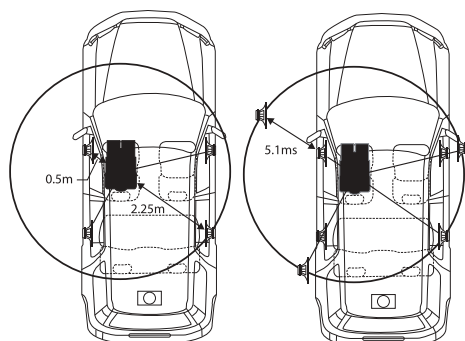

The sound is not balanced because the distance between the listening position and the various speakers is different.

The difference in distance between the front left speaker and the rear right speaker is 1.75 m (68-7/8").

Here we calculate the time correction value for the front left speaker in the diagram on the above.

Conditions:

Farthest Speaker – listening position : 2.25 m (88-9/16") Front

left speaker – listening position : 0.5 m (19-11/16") Calculation:

$L = 2.25\text{ m} - 0.5\text{ m} = 1.75\text{ m (68-7/8")}$

Time correction = $1.75 \div 343^* \times 1,000 = 5.1\text{ (ms)}$

* Speed of sound: 343 m/s (765 mph) at 20°C

In other words, giving the front left speaker a time correction value of 5.1 ms makes it seem as if its distance from the listener is the same as the distance to the farthest speaker.

Time correction eliminates the differences in the time required for the sound to reach the listening position.

The time of the front left speaker is corrected by 5.1 ms so that its sound reaches the listening position at the same time as the sound of other speakers.

Example 2. Listening Position: All Seats

Adjust the time correction level of each speaker to almost the same level.

1. Sit in the listening position (driver's seat, etc.) and measure the distance (in meters) between your head and the various speakers.
2. Calculate the difference between the distance correction value to the farthest speaker and the other speakers.

$L = (\text{distance to farthest speaker}) - (\text{distance to other speakers})$

These values are the time correction values for the different speakers. Setting these values to make each sound reach the listening position at the same time as the sound of other speakers.

Time Correction Value List

Time Difference (msec)	Distance (cm)	Distance (inch)	Time Difference (msec)	Distance (cm)	Distance (inch)
0.0	0.0	0.0	5.0	170.0	67.0
0.1	3.4	1.3	5.1	173.4	68.3
0.2	6.8	2.7	5.2	176.8	69.7
0.3	10.2	4.0	5.3	180.2	71.0
0.4	13.6	5.4	5.4	183.6	72.4
0.5	17.0	6.7	5.5	187.0	73.7
0.6	20.4	8.0	5.6	190.4	75.0
0.7	23.8	9.4	5.7	193.8	76.4
0.8	27.2	10.7	5.8	197.2	77.7
0.9	30.6	12.1	5.9	200.6	79.1
1.0	34.0	13.4	6.0	204.0	80.4
1.1	37.4	14.7	6.1	207.4	81.7
1.2	40.8	16.1	6.2	210.8	83.1
1.3	44.2	17.4	6.3	214.2	84.4
1.4	47.6	18.8	6.4	217.6	85.8
1.5	51.0	20.1	6.5	221.0	87.1
1.6	54.4	21.4	6.6	224.4	88.4
1.7	57.8	22.8	6.7	227.8	89.8
1.8	61.2	24.1	6.8	231.2	91.1
1.9	64.6	25.5	6.9	234.6	92.5
2.0	68.0	26.8	7.0	238.0	93.8
2.1	71.4	28.1	7.1	241.4	95.1
2.2	74.8	29.5	7.2	244.8	96.5
2.3	78.2	30.8	7.3	248.2	97.8
2.4	81.6	32.2	7.4	251.6	99.2
2.5	85.0	33.5	7.5	255.0	100.5
2.6	88.4	34.8	7.6	258.4	101.8
2.7	91.8	36.2	7.7	261.8	103.2
2.8	95.2	37.5	7.8	265.2	104.5
2.9	98.6	38.9	7.9	268.6	105.9
3.0	102.0	40.2	8.0	272.0	107.2
3.1	105.4	41.5	8.1	275.4	108.5
3.2	108.8	42.9	8.2	278.8	109.9
3.3	112.2	44.2	8.3	282.2	111.2
3.4	115.6	45.6	8.4	285.6	112.6
3.5	119.0	45.9	8.5	289.0	113.9
3.6	122.4	48.2	8.6	292.4	115.2
3.7	125.8	49.6	8.7	295.8	116.6
3.8	129.2	50.9	8.8	299.2	117.9
3.9	132.6	52.3	8.9	302.6	119.3
4.0	136.0	53.6	9.0	306.0	120.6
4.1	139.4	54.9	9.1	309.4	121.9
4.2	142.8	56.3	9.2	312.8	123.3
4.3	146.2	57.6	9.3	316.2	124.6
4.4	149.6	59.0	9.4	319.6	126.0
4.5	153.0	60.3	9.5	323.0	127.3
4.6	156.4	61.6	9.6	326.4	128.6
4.7	159.8	63.0	9.7	329.8	130.0
4.8	163.2	64.3	9.8	333.2	131.3
4.9	166.6	65.7	9.9	336.6	132.7

1. In the Setup screen, touch [Time Correction].

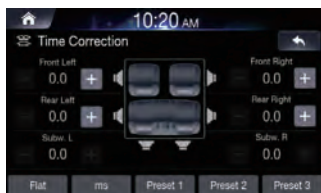

2. Touch the Correction Mode button and select the mode.

Each time the button is pressed, mode is changed from ms, inch and cm.

3. Touch [-] or [+] for each speaker to adjust the time or distance.

0.0 msec to 9.9 msec (0.1 msec/step)

0.0 cm (0.0 inch) to 336.6 cm (132.7 inch) (3.4 cm/step)

All speaker setting values are adjustable in the range of 15 ms or 510 cm.

4. To store the adjusted setting value, touch and hold [Preset 1], [Preset 2], or [Preset 3] for at least 2 seconds.

- Touch [Flat] to set all values to 0.0.
- If the Subwoofer setting is "Off," the Subwoofer setting cannot be edited.

Calling the Time Correction Value

Calling the pre-set time correction value.

Touch [Preset 1], [Preset 2], or [Preset 3] on the time correction screen.

The setting stored in the Preset will be recalled.

Setting Defeat

Defeat is "On," MX HD and Equalizer Presets features are turned off. This disables any settings made for these functions.

Check the [Off] box to turn the feature on.

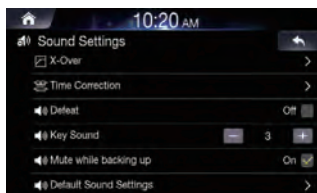

Uncheck the [On] box to turn the feature off.

Setting Key Sound

You can change the volume of the sound heard when a button is touched.

Adjust the sound level from 0 to 6.

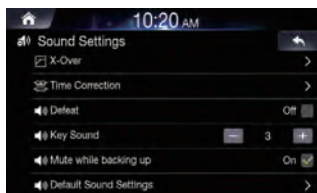

Setting Audio Mute On/ Off while Reversing

- 1 Select the desired option from Off and On.

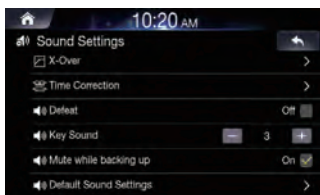

- *Mute while backing up* - feature used to control audio upon switching to reverse.
- *On* - Mutes sound while playing.
- *Off* - Maintains the currently playing sound.

Default Sound Settings

This feature is used to restore all sounds settings back to default state.

- 1 In the Sound Settings screen, touch [Default Sound Settings].

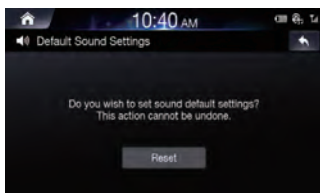

- 2 Touch [Reset]. A popup stating "Initialized to factory settings." will be displayed.

Visual Settings

This feature is used to adjust the Brightness, Saturation, Contrast and Hue levels.

- 1 In the Setup screen, touch [Visual].

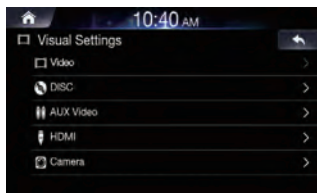

- "Video" can be selected while a video is playing.

Setting Brightness/Contrast/Saturation/Hue

- 1 In the Visual Settings screen, touch the desired menu.

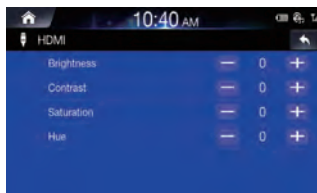

- 2 Use [+] and [-] to adjust settings from -5 to +5.

- *In the Video visual settings, [Hue] is not supported.*

Screen Settings

This menu allows you to set the display settings for the whole system

In the Setup screen, touch [Screen].

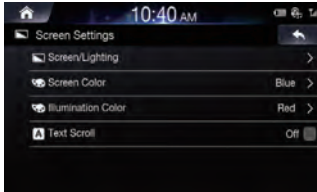

Setting Screen/Lighting

In the Screen Settings screen, touch [Screen/Lighting].

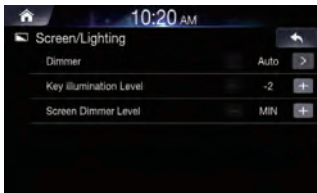

■ Setting Dimmer

Backlighting is provided by LED lights built into the liquid crystal panel. The illumination control adjusts the brightness of the backlighting based on the car ambient lighting for easier viewing.

Set the desired value from Auto, On and Off.

Auto: Adjust the brightness of the background illumination of the monitor automatically to the brightness of the car interior.

On: Keep the background illumination of the monitor dark.

Off: Deactivate Auto Dimmer mode to keep the background illumination of the monitor bright.

- The Key Illumination Level and Screen Dimmer Level feature are unavailable when the Dimmer value is set to "Off".

■ Setting Key Illumination Level

You can adjust the brightness of the button lighting at night with the dimmer.

Adjust the value from -2 to +2.

This setting is only available when "Dimmer" is set to "On."

■ Setting Screen Dimmer Level

You can adjust the brightness of the backlight. This function could be used, for instance, to change the screen brightness while travelling at night.

Adjust the value from -15 to +15.

You can adjust the level between MIN (-15) and MAX (+15). When it reaches the minimum or maximum point, the display shows "MIN" or "MAX" respectively.

- This setting is only available when "Dimmer" is set to "On" or "Auto."

Setting Screen Colour

You can choose the screen colour from 5 different colours.

1 In the Screen Settings screen, touch [Screen Colour].



2 Select the desired colour.

Setting Illumination Colour

You can choose the colour of the Front Panel button from one of 7 colours.

In the Screen Settings screen, touch [Illumination Colour].

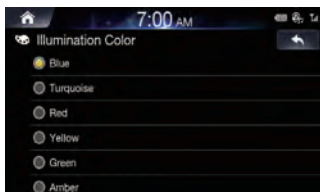

Setting Text Scroll

Scroll display is available if folder name, file name or tag information is entered.

Check the [Off] box to turn the feature on.

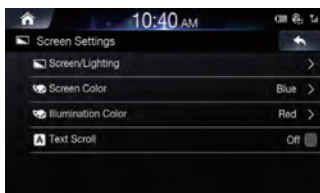

- Uncheck the [On] box to turn the feature off.

General Setup

You can set up items related to the language, etc.

In the Setup screen, touch [General].

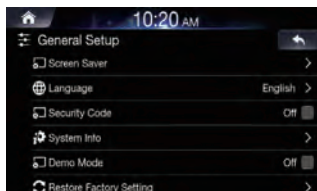

Setting Screen Saver

This feature is used to display a screen saver when the monitor is off.

1 In the General Settings screen, touch [Screen Saver].

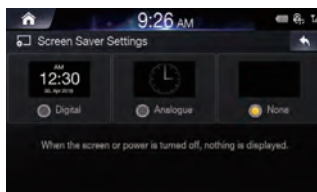

2 Select the desired option.

- *Digital*: the screen will display the digital clock.
- *Analogue*: the screen will display the analogue clock.
- *None*: the screen will remain off.

Setting Language

This menu allows you to set the language of the system.

1 In the General Settings screen, touch [Language].

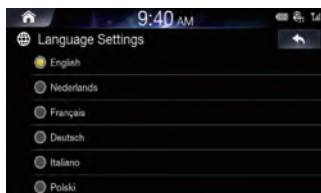

2 Select the desired language.

English / Nederlands / Français / Deutsch / Italiano / Polski / Русский / Español / 中文

Setting Security Code

You can set the system to be unusable without entering a password. When you turn this setting to "On" and set a password, password input is required when the system is connected to a battery and turned on for the first time.

■ Setting the security Code

1. Check the [Off] box to turn the feature on and touch [OK].

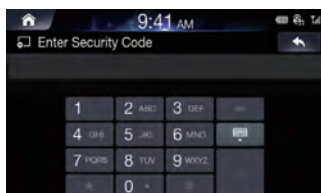

2. Enter the password and touch [OK].

- Enter the 6-10 digit number.
- Touch [←] to delete an entered number.

3. Enter the same password again and touch [OK].

The security code is set and the system returns to the General Setup Menu screen, then the checkbox of the Security Code is set to "On".

- If you forget a registered password, you cannot use this unit. In this case, service will be required.

■ Clearing the security Code

1. Uncheck the [On] box.

The password setting screen is displayed.

2. Enter the password you have set and touch [OK].

The password is cleared, and the system returns to the General Setup Menu screen, then the checkbox of the Security Code is set to "Off".

Viewing System Info

You can view the version information of this product. Make note of this information and refer to it whenever you contact Alpine Tech Support or an Alpine-authorized dealer.

In the General Settings screen, touch [System Info].

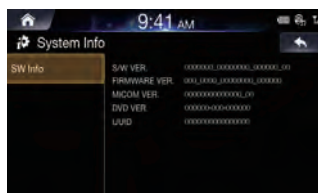

Setting Demo Mode

This unit has a Demonstration feature for the display. To quit demo mode, set Demo mode to Off.

- 1 Uncheck the [On] box to turn the feature off.

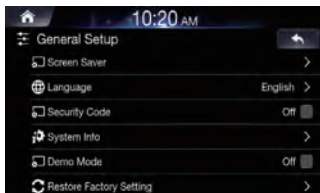

- 2 Check the [Off] box to turn the feature on. To start Demo mode, refrain from operating the system for 30 seconds. Please wait.

- If you perform an operation during the Demo mode, the demonstration is temporarily stopped.

Initializing the System

You can initialise all data, to restore the factory settings. Remove the USB flash drive, etc. from the system before operation.

- 1 In the General Settings screen, touch [Restore Factory Setting].

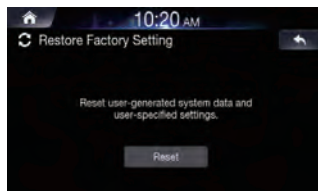

- 2 Touch [Reset] → [Yes].

- Do not turn on/off the power, change the ignition key position or remove the screen panel until system restart is completed.

Car Settings

In the Setup screen, touch [Car].

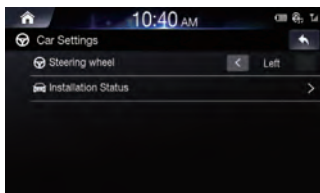

Setting Steering Wheel

Set this item when Apple CarPlay is used.
This setting influences Apple CarPlay mode.

Select the desired option from Left and Right.

Setting Installation Status

Vehicle Setup enables you to check the connection status of Reverse Lead/Parking Brake Lead.

In the Car Settings screen, touch [Installation Status].

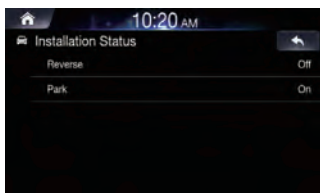

AUX Setup

You can set up the items related to the Auxiliary device.

In the Setup screen, touch [AUX].

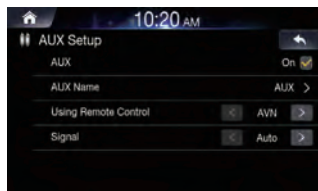

- This setting cannot be changed while the AUX source is being selected.
- This setting is only available when "AUX" is set to "On".

Turning AUX On/Off

Check the [Off] box to turn the feature on.

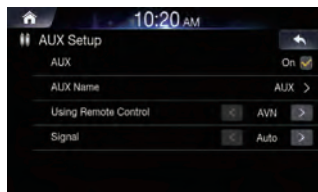

Uncheck the [On] box to turn the feature off.

Setting AUX Name

- 1 In the AUX Settings screen, touch [AUX Name].

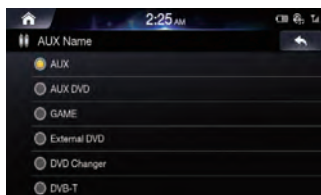

- 2 Select the desired name.

AUX / AUX DVD / GAME / External DVD / DVD Changer / DVB-T / TV / USB Player

Using Remote Control

- 1 Check the [AVN] box to turn the feature on.

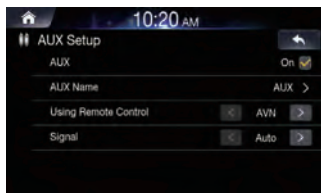

- 2 Uncheck the [RSE] box to turn the feature off.

- AVN: AUX is operated through the remote controller signal from the Remote Sensor.
- RSE: AUX is operated using the remote controller signal delivered from the device connected with the RSE.

Setting Signal

You can switch the visual input signal system.

Select the desired option.

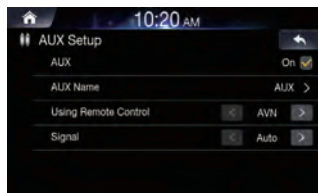

- Auto: the video input signal type (NTSC or PAL) will be automatically selected.
- NTSC/PAL: choose the video input signal type manually.

HDMI Settings

You can set the name of an external device connected via HDMI.

- 1 In the Setup screen, touch [HDMI].

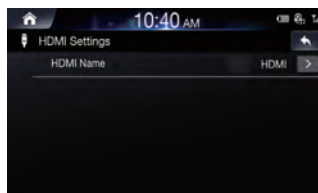

- 2 Select the desired name.

- HDMI: set when a smartphone is connected via HDMI.
 - DVD: set when an external DVD player is connected.
- This setting cannot be changed while the HDMI source is being selected.

Camera Settings

You can set up items related to the Camera.

In the Setup screen, touch [Camera].

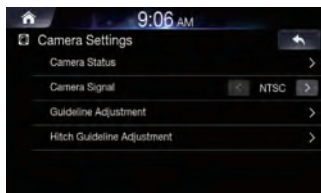

Setting Camera Status

You can set the camera input.

1 In the Camera Settings screen, touch [Camera Status].

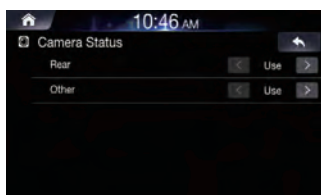

2 Set whether to use rear camera or other cameras.

- Rear: Rear camera
- Other: Side camera, Interior camera, etc.

Setting Camera Signal

You can switch the video input signal system.

Select the desired option.

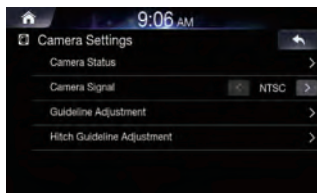

- Auto: the video input signal type (NTSC or PAL) will be automatically selected.
- NTSC/PAL: choose the video input signal type manually.

Setting Camera Guideline

The camera guideline can be changed when connected to Rear View Camera.

This item cannot be selected when the rear camera status is set to "Off" or "Other".

1 In the Camera Settings screen, touch [Guideline Adjustment].



2 Touch the guideline you intend to adjust.

Guideline can also be selected by touching [▲, ▼].

- You cannot adjust the position of the yellow guideline in the centre independently.

It is controlled by a system to be the centre of the two yellow guidelines on the left and right, or the central green line and red guide line.

3 Touch [▲, ▼, ◀, ▶] to adjust the position of the guideline.

- Touching [Clear] clears adjustments and returns to the setting before guideline alteration.

4 After the adjustment is completed, touch [Set].

■ Turning Guideline Display On/Off

1. Select the guideline.
 2. Touch [On/Off].
The currently selected guide will turn off.
 3. To turn the guideline on, touch [On/Off] again.
- Guidelines that are turned off are still adjustable.

■ Returning Guideline to Default

1. Touch [Default]

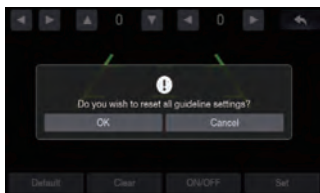

2. Touch [OK].
Adjusted values will return to default settings

■ Setting Hitch Guideline

1. In the Camera Settings screen, touch [Hitch Guideline Adjustment].

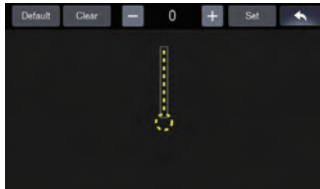

2. Touch the guideline you intend to adjust.
Guideline can also be selected by touching [▲, ▼].
3. Touch [-, +] to adjust the position of the guideline.
4. After the adjustment is completed, touch [Set].

Connectivity Settings

This menu allows you to set the car connectivity of your system.

In the Setup screen, touch [Connectivity].

Setting Android Auto

- 1 In the Connectivity Settings screen, touch [Android Auto].

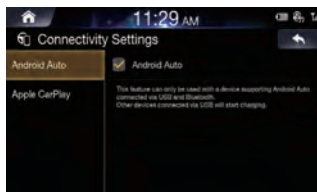

- 2 Check to use your Android phone with Android Auto.

If Android Auto is checked, you can use the functions of your Android phone with a USB cable and Bluetooth connected. It enables the Android Auto functions.

- While Android Auto is running, you cannot use any of Bluetooth Audio.

Setting Apple CarPlay

This menu allows you to set connectivity When iPhone is connected using a USB cable.

- 1 In the **Connectivity Settings** screen, touch **[Apple CarPlay]**.

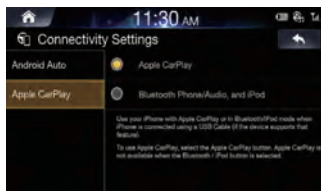

- 2 Select the desired option.
 - **Apple CarPlay:** uses your iPhone with Apple CarPlay
 - **Bluetooth Phone/Audio and iPod:** uses your iPhone in Bluetooth/iPod mode.

 - This setting is invalid for music playing of iPhone 4S and iPod.

Date/Time Settings

This feature is used to set the time and date shown within the system.

- 1 In the **Setup** screen, touch **[Date/Time]**.



- The **Date/Time** feature is unavailable when **GPS time** is being used. To change the date/time manually, turn off the **[GPS Time]** feature.

- 2 Adjust the date and time.
 - **DD/MM:** displays the date in order of day > month
 - **MM/DD:** displays the in order of month > day.

Receiving GPS Time

Check the **[GPS Time]** box to display the received GPS Time.

- The **Date/Time** feature is unavailable when **GPS time** is being used.

Converting Time Format

Check/uncheck the **[24 Hours]** box to convert the digital clock display to 24 or 12 hours.

Turning Daylight Savings Time On/Off

Check the **[Daylight Savings Time]** box to turn the feature on.

Camera Operation

When an optional camera is connected, the view video of camera can be output to the monitor.

Front camera or Rear camera can be connected to this unit. Make the Camera Status Setting (Rear or Other) according to your connected camera.

Rear camera:

If an HCE-C127D/HCE-C157D/HCE-C252RD, etc., camera is connected, when the vehicle is reversed, the rear camera view (guide marks for vehicle width and available distance) is displayed automatically on the screen of this unit.

Other camera:

Set when connecting to a camera other than the Rear camera, such as a front camera.

You can adjust the quality of the camera image. Setting items: Brightness / Colour / Contrast/Hue. Refer to "Visual Settings".

Rear Camera Operation

Displaying the Rear Camera Image from the Menu screen

- 1 Press the All Menus  button.
Or in the Home screen, touch [All Menus].

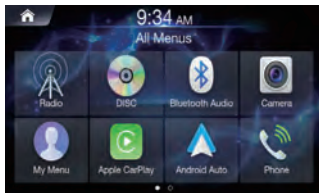

- 2 Touch [Camera].



- Touch [←] to return the previous screen.
- You can perform a Guideline Adjustment. For details, see "Setting Camera Guideline".
- The guidelines will be displayed (or hidden) depending on whether the Guide is turned On/Off.

Displaying the rear view video while the car is in reverse

1. **Shift the gear lever to the reverse (R) position.**
The rear view image is displayed while the car remains in reverse.
2. **If you shift the gear lever to a position other than reverse (R), the monitor returns to the previous screen.**
 - Never depend solely on the camera when backing up. Always turn and look and only use the camera for additional assistance.
 - This function is effective when the reverse wire is properly connected.
 - You can perform a Guideline Adjustment. For details, see "Setting Camera Guideline".

Guideline Display ON/OFF

1. **Touch the screen when the image from the camera is displayed.**
The operation screen is displayed on the screen.
 - After a 5-second time-out, the operation screen returns to the camera display screen.
2. **Touch [Guide Off] on the Rear camera display screen.**
The guide disappears, and then the [Guide Off] switch changes to [Guide On].
3. **Touch [Guide On] to turn on the guide.**

Hitch Guideline Display On/OFF

1. **Touch the screen when the image from the camera is displayed.**
The operation screen is displayed on the screen.
 - After a 5-second time-out, the operation screen returns to the camera display screen.
2. **Touch [Hitch Guide On] on the Rear camera display screen.**
The hitch guideline is displayed, and then the [Hitch Guide On] switch changes to [Hitch Guide Off].
3. **Touch [Hitch Guide Off] to turn off the guide.**

Switching the Front Camera image

1. **Touch the screen when the image from the camera is displayed.**
The operation screen is displayed on the screen.
 - After a 5-second time-out, the operation screen returns to the camera display screen.
2. **Touch [Other View] on the Rear camera display screen.**
The Front Camera View is displayed, and then the [Other View] switch changes to [Rear View].
3. **Touch [Rear View] to display the Rear Camera View.**

About the Rear Camera Guideline

To display the guideline, turn guideline on. Also, to adjust the guide, see "Setting Camera Guideline". You can also turn off the guideline in the Rear camera display screen.

■ Indication mark meaning

When the car is put into reverse gear, the monitor switches to the rear view camera image. Guides appear to help visualise the car's width and distance from the rear bumper.

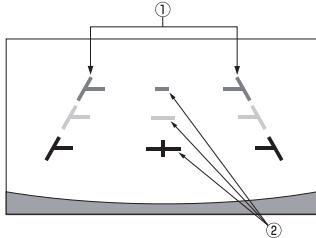

1. Car width extension marks (red, yellow and green in order of distance)

If properly calibrated, the marks indicate the car's width. This helps guide the car's path when backing up in a straight line. The marks represent the distance from the rear of the car (from the rear end of the bumper).

The marks do not move in synchronisation with the steering wheel. Set the marks to suit the car's width.

2. Distance guidance marks

The marks represent the distance from the rear of the car (from the rear end of the bumper).

- The marks do not move in synchronisation with the steering wheel.
- We recommend that you measure the actual distance to the marks when parked on a level surface.
- Depending on the condition of the car or road surface, the range of vision may vary.
- The camera has a limited range of vision. Objects at extreme angles to the camera (e.g. under the bumper or at opposite ends of the bumper) may not be in its field-of-vision.
- The rear camera image may have a tint which is different from the actual surroundings.
- Depending on the car, the guidance may deviate to the right or left. This is not a malfunction.

■ Distance guidance mark

The distance guides represent the ground level distance from the rear bumper. It is difficult to accurately estimate the distance to objects above ground level.

In the following example, the distance to A is 0.5 m and the distance to B is 1 m.

<Screen>

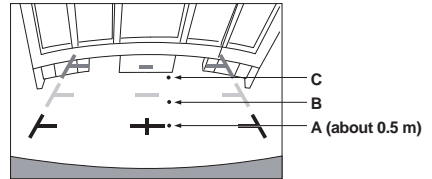

<Positions of A, B and C>

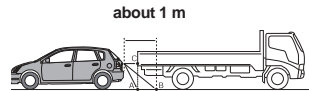

In the screen, according to the distance guidance marks, the truck seems to be parked about 1 m away (at the position B). In actual fact, however, if you reversed to position A, you would collide with the truck.

In the screen, positions A, B and C seem to be located in order of proximity. However, in actual fact, the position A and C are the same distance, and B is farther away than positions A and C.

- The car width extension mark represents the distance to the road surface. The distance to an object on the road is not accurately represented by the guides.

Error between the screen and the actual road surface

In the following conditions, errors are produced between the screen guidance and the actual road surface. (The illustrations represent a case when the camera is installed in the standard position.)

■ When there is a steep upward slope behind the car (example)

<Screen>

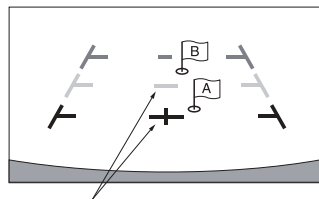

Distance guidance marks

<Situation of the car>

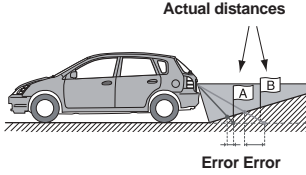

The distance guidance mark represents the distance to a flat road surface. Therefore, in the case of an upward slope behind the car, the distance guides are displayed closer to the rear bumper than the actual distance. For example, if there is an obstacle on the upward slope, it may appear farther away than its actual position. Also, an error may occur between the guidance and the actual path of the car on the road surface.

■ When there is a steep downward slope behind the car (example)

<Screen>

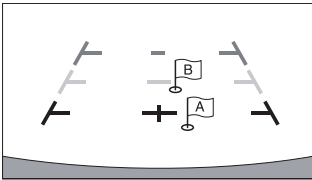

<Situation of the car>

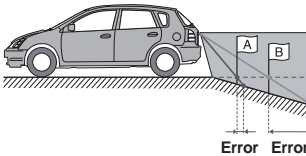

In the case of a downward slope behind the car, the distance guides are displayed farther from the rear bumper than the actual distance. If there is an obstacle on the downward slope, it seems closer than its actual position. Also, an error may occur between the guidance and the actual path of the car on the road surface.

Information

Product Software Update

This product uses software that can be updated through a USB flash drive. Download the software from the Alpine website and update the product using the USB flash drive.

Updating this product

Check the Alpine website for details on updating.
<http://www.alpine-europe.com>

Important information on the software

About the software licence of the product

The software installed in the product contains open-source software. See the following Alpine website for details on the open source software.

<http://www.alpine.com/e/research/oss/>

About the Supported Formats

For the list of video formats supported from a USB flash drive, see "Supported USB Video Format" (page 42).

About MP3/WMA/AAC/FLAC/OGG/APE/MP2

Caution

Except for private use, duplicating audio data (including MP3/WMA/AAC/FLAC/OGG/APE/MP2 data) or distributing, transferring, or copying it, whether for free or for a fee, without permission of the copyright holder is strictly prohibited by the Copyright Act and by international treaty.

What is MP3?

MP3, whose official name is "MPEG-1 Audio Layer 3," is a compression standard prescribed by the ISO, the International Standardisation Organisation and MPEG which is a joint activity institution of the IEC.

MP3 files contain compressed audio data. MP3 encoding is capable of compressing audio data at extremely high ratios, reducing the size of music files to as much as one-tenth their original size. This is achieved while still maintaining near CD quality. The MP3 format realises such high compression ratios by eliminating the sounds that are either inaudible to the human ear or masked by other sounds.

What is WMA?

WMA, or "Windows Media™ Audio," is compressed audio data. WMA is similar to MP3 audio data.

What is AAC?

AAC is the abbreviation for "Advanced Audio Coding," and is a basic format of audio compression used by MPEG2 or MPEG4.

What is FLAC?

FLAC (Free Lossless Audio Codec) is an audio file codec for lossless compression, developed and offered as open source software. Codecs with lossy compression forms, such as MP3 and AAC, reduce part of the data to improve compression efficiency. However, FLAC can reconstruct compressed data to be an identical copy of the original data by performing lossless compression. The compression ratio of FLAC is about 50%.

Method for creating MP3/WMA/AAC/FLAC (USB Flash drive) files

Audio data is compressed using software with MP3/WMA/AAC/FLAC (USB Flash drive) codecs. For details on creating MP3/WMA/AAC/FLAC (USB Flash drive) files, refer to the user's manual for that software.

MP3/WMA/AAC/FLAC (USB Flash drive) files that are playable on this device have the file extensions.

MP3: "mp3"
WMA: "wma"
AAC: "aac"
FLAC: "flac"/"fla"
OGG: "ogg"
APE: "ape"
MP2: "mp2"

WMA is not supported for the following files, Windows Media Audio Professional, Windows Media Audio 10 std or Windows Media Audio 10 Pro Lossless.

There are many different versions of the AAC format. Confirm that the software being used conforms to the acceptable formats listed above. It's possible that the format may be unplayable even though the extension is valid.

Playback of AAC files encoded by iTunes is supported.

Supported playback sampling rates and bit rates

MP3 (USB Flash drive)

Sampling rates: 48 kHz, 44.1 kHz, 32 kHz, 24 kHz, 22.05 kHz, 16 kHz, 12 kHz, 11.025 kHz, 8 kHz

Bit rates: 8 - 320 kbps

WMA (USB Flash drive)

Sampling rates: 48 kHz, 44.1 kHz, 32 kHz, 22.05 kHz, 16 kHz, 11.025 kHz, 8 kHz

Bit rates: 48 - 320 kbps

AAC (USB Flash drive)

Sampling rates: 48 kHz, 44.1 kHz, 32 kHz, 24 kHz, 22.05 kHz, 16 kHz, 12 kHz, 11.025 kHz, 8 kHz

Bit rates: 16 - 320 kbps

FLAC (USB Flash drive)

Sampling rates: 96kHz, 88.2kHz, 48kHz, 44.1kHz, 32kHz, 24kHz, 22.05kHz, 16kHz, 8kHz

Channel number: 1ch, 2ch

This device may not play back correctly depending on sampling rates.

OGG (USB Flash drive)

Sampling rates: Up to 48kHz

Bit rates: 8 - 500 kbps

APE (USB Flash drive)

Sampling rates: Up to 48kHz

Channel number: 1ch, 2ch

MP2 (USB Flash drive)

Sampling rates: Up to 48kHz

Bit rates: 16 - 384 kbps

ID3 tags/WMA tags

This device supports ID3 tag v1.0, v1.1, v2.2, v2.3, v2.4, and WMA tag Ver.1.x. If tag data is in an MP3/WMA/AAC file, this device can display the title (track title), artist name, and album name ID3 tag/WMA tag data.

For non-supported characters, "?" is displayed.

The number of characters may be limited, or not correctly displayed, depending on the tag information.

Playing back MP3/WMA/AAC/FLAC/OGG/APE/MP2

MP3/WMA/AAC/OGG/APE/MP2 files are prepared, then written to a USB flash drive.

- Maximum numbers of playable files/folders USB Flash drive: 5,000 files/ 2,000 folders (including Root Folder)
- Largest playable file size: 512 MB

Playback may not be performed if a disc exceeds the limitations described above.

If a file/folder name is long, the maximum possible number of files may decrease.

- Both Audio and Video files are counted if their formats are playable on this unit.

Media supported

The media that this device can play back a USB flash drive.

Corresponding File Systems

This device supports FAT 16/32.

The maximum nested folder depth is 15 (including the root directory).

File names are limited to 256 characters (including the extension).

Valid characters for folder/file names are letters A-Z (all caps), numbers 0-9, and '_' (underscore), Special Characters -!@#%&()*+ -=:;.,{} (except : \ / * ? " < > |).

Order of files

Files are played back in the order that the writing software writes them to the disc. Therefore, the playback order may not be what's expected. Verify the writing order in the software's documentation.

The playback order of the folders and files is as follows. (The following numbers may differ from actually displayed numbers.)

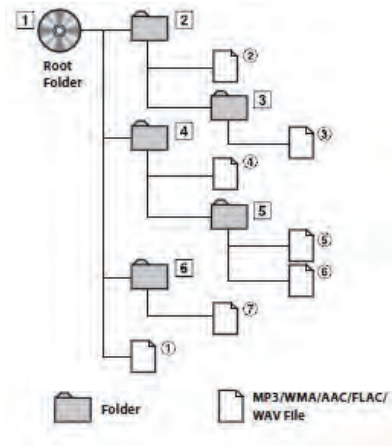

Terminology

Bit rate

This is the "sound" compression rate specified for encoding. The higher the bit rate, the higher the sound quality, but also the larger the files.

Sampling rate

This value shows how many times per second the data is sampled (recorded). For example, music CDs use a sampling rate of 44.1 kHz, so the sound is sampled (recorded) 44,100 times per second. The higher the sampling rate, the higher the sound quality, but also the larger the volume of data.

Encoding

Converting music CDs, WAVE (AIFF) files, and other sound files into the specified audio compression format.

Tag

Song information such as track titles, artist names, album names, etc., written into MP3/WMA/AAC/FLAC/OGG/APE/MP2 (USB flash drive) files.

Root folder

The root folder (or root directory) is found at the top of the file system. The root folder contains all folders and files. It is created automatically for all burned discs.

In Case of Difficulty

If you encounter a problem, please turn the power off, then on again. If the unit is still not functioning normally, please review the items in the following checklist. This guide will help you isolate the problem if the unit is at fault. Otherwise, make sure the rest of your system is properly connected, or then consult your authorized Alpine dealer.

Basic

No function or display.

- Vehicle's ignition is off.
 - If connected according to the instructions, the unit will not operate with the vehicle's ignition off.
- Improper power lead connections.
 - Check power lead connections.
- Blown fuse.
 - Check the fuse on the battery lead of the unit; replace with the proper value if necessary.
- Internal micro-computer malfunctioned due to interference noise, etc.
 - Press the RESET switch with a ballpoint pen or other pointed article.

No sound or unnatural sound.

- Incorrect setting of volume/balance/fader controls.
 - Readjust the controls.
- Connections are not properly or securely made.
 - Check the connections and firmly connect.

Screen not displayed.

- Brightness/Contrast control is set at the minimum position.
 - Adjust the Brightness/Contrast control.
- Temperature in the vehicle is too low.
 - Increase the vehicle's interior temperature to operation temperature range.
- Connections to the Auxiliary Device are not securely made.
 - Check the connections and firmly connect.
- The Parking Brake Lead is not connected.
- The Parking Brake is not engaged.
 - Connect the Parking Brake Lead, then engage the Parking Brake.

Movement of displayed picture is abnormal.

- Temperature in the vehicle is too high.
 - Allow the vehicle's interior temperature to cool.

The optional remote control is inoperative.

- The remote control sensor setting of "Using Remote Control" (page 76) is not set to this unit ("AVN")
 - Set for "AVN"

Radio

Unable to receive stations.

- No antenna, or open connection in the antenna cable.
 - Make sure the antenna is properly connected; replace the antenna or cable if necessary.

Unable to tune stations in the seek mode.

- You are in a weak signal area.
 - Make sure the tuner is in DX mode.
- If the area you are in is a primary signal area, the antenna may not be grounded and connected properly.
 - Check your antenna connections; make sure the antenna is properly grounded at its mounting location.
- The antenna may not be the proper length.
 - Make sure the antenna is fully extended; if broken, replace the antenna with a new one.

Broadcast is noisy.

- The antenna is not the proper length.
 - Extend the antenna fully; replace it if it is broken.
- The antenna is poorly grounded.
 - Make sure the antenna is grounded properly at its mounting location.
- The station signal is weak and noisy.
 - If above solution does not work, tune in another station.

USB Audio

Unit does not operate.

- Condensation.
 - Wait a while (about 1 hour) for the condensation to dry.

Picture is unclear or noisy.

- Vehicle's battery power is weak.
 - Check the battery power and wiring. (The unit may malfunction if the battery power is under 11 volts with a load applied.)

Rear Seat Entertainment System

DVD sound is not being output from the rear monitor headphones.

- The external audio processor and DVD Player (DVE-5300) are optically connected.
 - Set the Audio Out of the DVD Player to "LPCM."

Navigation

The Navigation cannot work properly.

- Reset Navigation system.
 - Turn the ignition key off, and then set to ON again.

Error Messages

Various messages are displayed on the screen during operation. In addition to the messages telling you the current status or providing guidance for the next operation, there are also the following error messages. If one of these error messages is displayed, carefully follow the instructions in the solution column.

System

If you are driving, please pull over before using this function.

- A setup operation, etc., was carried out while the vehicle was running.
 - Move the vehicle to a safe location, stop, and engage the parking brake, then carry out this operation.

USB current error.

- Abnormal current is run to the USB connector device.
 - Turn the ignition key off, and then set to ON again.
 - Attempt to connect another iPod/iPhone/Android Phone/USB Flash drive.

USB HUB is not supported.

- A USB flash drive with a hub is connected.
 - You cannot play back from a USB flash drive with a hub. USB hub connections are also not supported.

File Format not supported.

- A USB Video file that is not supported by this unit is selected.
 - Check if the video file is playable by seeing "Supported USB Video Format" (page 42).

Audio/Visual

Connected USB device is not supported.

- An iPod/iPhone/Android Phone that is not supported by the unit is connected.
 - Connect an iPod/iPhone/Android Phone that is supported by the unit.
 - Reset the iPod.
- A USB device that is not supported by the unit is connected.
 - Attempt to connect another USB flash drive.
- Communication error.
 - Turn the ignition key off, and then set to ON again.
 - Check the display by reconnecting between the iPod/iPhone/Android Phone and the unit, using the iPod/iPhone/Android Phone cable.
 - Check the display by reconnecting between the USB flash drive and the unit.
- Caused by the iPod/iPhone/Android Phone Software Version not being compatible with this unit.
 - Update the iPod/iPhone/Android Phone Software Version to be compatible with this unit.
- The iPod/iPhone/Android Phone is not verified.
 - Change to another iPod/iPhone/Android Phone.

No data.

- There are no data in the iPod/iPhone/Android Phone.
 - Download data to the iPod/iPhone/Android Phone and connect to the unit.
- There are no data in the USB flash drive.
 - Download data to the USB flash drive and connect to this unit.

Un-readable song was skipped.

- A copy-protected WMA file has been detected.
 - You can only play back non-copy-protected files.

- A sampling rate/bit rate not supported by the unit is used.
 - Use a sampling rate/bit rate supported by the unit.

DAB Antenna error

- The DAB antenna cable is either damaged or not connected correctly to the product.
 - Check that the antenna cable is not kinked or otherwise damaged. Replace the antenna if necessary.
- Abnormal current is run to the DAB Antenna.
 - Connect the antenna properly to a car with a 12 volt negative ground.

Bluetooth

Please connect Bluetooth audio device.

- The Bluetooth audio device was not connected correctly.
 - Check the settings for the unit and the Bluetooth audio device and reconnect.

Unable to download phonebook.

- Phonebook failed to read due to mobile phone disconnection, etc.
 - Check the mobile phone connection, and then conduct synchronising and adding again. (See page 58)
- The connected mobile phone does not support synchronising of its phone book.
 - Connect the mobile phone that supports synchronising the phone book, then synchronise again. (See page 58)

HDMI

HDMI communication error.

Please check your device and operate it again.

- Communication error.
 - Turn the ignition key off, and then set to ON again.
 - Check the display by reconnecting between the HDMI and the unit, using the HDMI cable.
 - Check the display by reconnecting between the HDMI device and the unit.

HDMI current error.

Please Connect your device again.

- Abnormal current is run to the HDMI connector device.
 - Turn the ignition key off, and then set to ON again.
 - Disconnect the HDMI device from the unit, and then reconnect it.

HDMI monitor communication error.

Please check the connection or ACC off / on.

- HDMI device communication error.
 - Turn the engine (ACC) OFF/ON. Or, check the HDMI cable where it connects to the HDMI monitor.

Monitor connect via HDMI has been exceeded.

Please check the connection.

- More than 4 HDMI monitors are connected.
- A cascade connection using more than 2 distributors is made.
 - Use one distributor and less than 4 HDMI monitors when connecting.

Navigation

The vehicle's position is erroneous.

- The GPS reception is poor.

- Drive the vehicle in an area of good GPS reception to allow the unit to recalibrate itself. Move to a location where strong GPS reception is possible.

No operation

- Moisture condensation

- Allow enough time for the condensation to evaporate (about 1 hour).

- Ambient Temperature

- Make sure the temperature inside the vehicle is between 0°C and 45°C (32°F and 113°F).

Specifications

MONITOR SECTION

Screen Size	6.5" (INE-W611D)
LCD Type	Transparent type TN LCD
Operation System	TFT active matrix
Number of Picture Elements	1,152,000 pcs. (800 × 480 × 3 (RGB))
Effective Number of Picture Elements	99% or more
Illumination System	LED

FM TUNER SECTION

Tuning Range	87.5 – 108.0 MHz
Mono Usable Sensitivity	9.3 dBf (0.8 μ V/75 ohms)
50 dB Quieting Sensitivity	13.5 dBf (1.3 μ V/75 ohms)
Alternate Channel Selectivity	80 dB
Signal-to-Noise Ratio	65 dB
Stereo Separation	35 dB

AM TUNER SECTION

Tuning Range	531 -1,602KHz
Usable Sensitivity	25.1 μ V/28 dBf

MW TUNER SECTION

Tuning Range	531 – 1,602 kHz
Usable Sensitivity	25.1 μ V/28 dBf

LW TUNER SECTION

Tuning Range	153 – 281 kHz
Sensitivity (IEC Standard)	31.6 μ V/30 dBf

DAB SECTION

Tuning Range BAND III	174.928 - 239.2 MHz
Tuning Range L-BAND	1,452.96 - 1,490.624 MHz
Usable Sensitivity	-101 dBm
Signal-to-Noise Ratio	85 dB

USB SECTION

USB requirements	USB 2.0
Max. Power Consumption	1,500 mA (CDP Support)
USB Class	USB (Mass Storage Class)
File System	FAT16/32
Decoding Format	MP3/WMA/AAC/FLAC/OGG/APE/MP2
Number of Channels	2-Channels (Stereo)
Frequency Response*1	5 – 20,000 Hz (\pm 1 dB)
Total Harmonic Distortion	0.016% (at 1 kHz)
Dynamic Range	95 dB (at 1 kHz)
Signal-to-Noise Ratio	85 Db
Channel Separation	75 dB (at 1 kHz)

*1 Frequency response may differ depending on the encoder software/bit rate.

HDMI SECTION

Input Format 480p/720p

GPS SECTION

GPS Reception frequency 1,575.42 ±1 MHz

GPS Reception sensitivity -130 dBm max.

Bluetooth SECTION

Bluetooth Specification Bluetooth v4.0
Frequency band 2,402 – 2,480 MHz
Output Power -6~+4 dBm Ave. (Power class 2)
Profile HFP (Hands-Free Profile)
PBAP (Phone Book Access Profile)
A2DP (Advanced Audio Distribution Profile)
AVRCP (Audio/Video Remote Control Profile)

GENERAL

Power Requirement 14.4 V DC
(11~16 V allowable)

Operating temperature -4°F to +140°F
(-20°C to + 60°C)

Maximum Power Output 50 W x 4

• Power output: measured at 4 Ohms and ≤ 1% THD+N

• S/N: 80 dBA (reference: 1 W into 4 Ohms)

Audio output level
Preout (Front, Rear): 4V/10k ohms (max.)
Preout (Subwoofer): 4V/10k ohms (max.)
Weight(unit only) 2.05 kg

CHASSIS SIZE

Width 178 mm
Height 100 mm
Depth 142 mm

NOSE SIZE

Width 178 mm
Height 100 mm
Depth 21.3 mm

- Due to continuous product improvement, specifications and design are subject to change without notice.
- The LCD panel is manufactured using an extremely high precision manufacturing technology. Its effective pixel ratio is over 99.99%. This means that there is a possibility that 0.01% of the pixels could be either always ON or OFF.

About the Rules of Bluetooth Electromagnetic Radiation Regulation



Declaration of Conformity

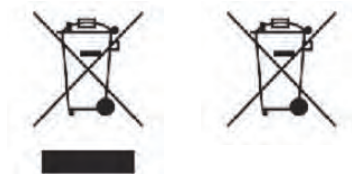

Information on Disposal of Old Electrical and Electronic Equipment and Battery (applicable for countries that have adopted separate waste collection systems)

If you want to dispose this product, do not mix it with general household waste. There is a separate collection system for used electronic products in accordance with legislation that requires proper treatment, recovery and recycling. Contact your local authority for details in Locating a recycle facility nearest to you. Proper recycling and waste disposal will help conserve resources whilst preventing detrimental effects on our health and the environment.